

Pioneer

ELITE

DVD PLAYER

DV-05

**Operating
Instructions**

CONGRATULATIONS ON YOUR PURCHASE OF THIS FINE PIONEER PRODUCT.

Pioneer is on the leading edge of DVD research for consumer products and this unit incorporates the latest technological developments.

We are sure you will be fully satisfied with the DVD player. Thank you for your support.

WARNING: TO PREVENT FIRE OR SHOCK HAZARD, DO NOT EXPOSE THIS APPLIANCE TO RAIN OR MOISTURE.

IMPORTANT NOTICE

[For U.S. and Canadian models]

The serial number for this equipment is located on the rear panel. Please write this serial number on your enclosed warranty card and keep it in a secure area. This is for your security.

CAUTION: This product satisfies FCC regulations when shielded cables and connectors are used to connect the unit to other equipment. To prevent electromagnetic interference with electric appliances such as radios and televisions, use shielded cables and connectors for connections.

THE POWER SWITCH IS SECONDARY CONNECTED AND THEREFORE DOES NOT SEPARATE THE UNIT FROM MAINS POWER IN STANDBY POSITION.

[For Canadian model]

CAUTION: TO PREVENT ELECTRIC SHOCK DO NOT USE THIS (POLARIZED) PLUG WITH AN EXTENSION CORD, RECEPTACLE OR OTHER OUTLET UNLESS THE BLADES CAN BE FULLY INSERTED TO PREVENT BLADE EXPOSURE.

ATTENTION: POUR PREVENIR LES CHOCS ELECTRIQUES NE PAS UTILISER CETTE FICHE POLARISEE AVEC UN PROLONGATEUR, UNE PRISE DE COURANT OU UNE AUTRE SORTIE DE COURANT, SAUF SI LES LAMES PEUVENT ETRE INSEREES A FOND SANS EN LAISSER AUCUNE PARTIE A DECOUVERT.

Please read through these operating instructions so you will know how to operate your model properly. After you have finished reading the instructions, put them away in a safe place for future reference.

- This player is not suitable for commercial use.

IMPORTANT



The lightning flash with arrowhead symbol, within an equilateral triangle, is intended to alert the user to the presence of uninsulated "dangerous voltage" within the product's enclosure that may be of sufficient magnitude to constitute a risk of electric shock to persons.

CAUTION

**RISK OF ELECTRIC SHOCK
DO NOT OPEN**

CAUTION:
TO PREVENT THE RISK OF ELECTRIC SHOCK, DO NOT REMOVE COVER (OR BACK). NO USER-SERVICEABLE PARTS INSIDE. REFER SERVICING TO QUALIFIED SERVICE PERSONNEL.



The exclamation point within an equilateral triangle is intended to alert the user to the presence of important operating and maintenance (servicing) instructions in the literature accompanying the appliance.

IMPORTANT SAFETY INSTRUCTIONS

READ INSTRUCTIONS — All the safety and operating instructions should be read before the product is operated.

RETAIN INSTRUCTIONS — The safety and operating instructions should be retained for future reference.

HEED WARNINGS — All warnings on the product and in the operating instructions should be adhered to.

FOLLOW INSTRUCTIONS — All operating and use instructions should be followed.

CLEANING — Unplug this product from the wall outlet before cleaning. The product should be cleaned only with a polishing cloth or a soft dry cloth. Never clean with furniture wax, benzene, insecticides or other volatile liquids since they may corrode the cabinet.

ATTACHMENTS — Do not use attachments not recommended by the product manufacturer as they may cause hazards.

WATER AND MOISTURE — Do not use this product near water — for example, near a bathtub, wash bowl, kitchen sink, or laundry tub, in a wet basement, or near a swimming pool; and the like.

ACCESSORIES — Do not place this product on an unstable cart, stand, tripod, bracket, or table. The product may fall, causing serious injury to a child or adult, and serious damage to the product. Use only with a cart, stand, tripod, bracket, or table recommended by the manufacturer, or sold with the product. Any mounting of the product should follow the manufacturer's instructions, and should use a mounting accessory recommended by the manufacturer.

CART — A product and cart combination should be moved with care. Quick stops, excessive force, and uneven surfaces may cause the product and cart combination to overturn.



VENTILATION — Slots and openings in the cabinet are provided for ventilation and to ensure reliable operation of the product and to protect it from overheating, and these openings must not be blocked or covered. The openings should never be blocked by placing the product on a bed, sofa, rug, or other similar surface. This product should not be placed in a built-in installation such as a bookcase or rack unless proper ventilation is provided or the manufacturer's instructions have been adhered to.

POWER SOURCES — This product should be operated only from the type of power source indicated on the marking label. If you are not sure of the type of power supply to your home, consult your product dealer or local power company.

LOCATION — The appliance should be installed in a stable location.

NONUSE PERIODS — The power cord of the appliance should be unplugged from the outlet when left unused for a long period of time.

GROUNDING OR POLARIZATION

- If this product is equipped with a polarized alternating current line plug (a plug having one blade wider than the other), it will fit into the outlet only one way. This is a safety feature. If you are unable to insert the plug fully into the outlet, try reversing the plug. If the plug should still fail to fit, contact your electrician to replace your obsolete outlet. Do not defeat the safety purpose of the polarized plug.
- If this product is equipped with a three-wire grounding type plug, a plug having a third (grounding) pin, it will only fit into a grounding type power outlet. This is a safety feature. If you are unable to insert the plug into the outlet, contact your electrician to replace your obsolete outlet. Do not defeat the safety purpose of the grounding type plug.

POWER-CORD PROTECTION — Power-supply cords should be routed so that they are not likely to be walked on or pinched by items placed upon or against them, paying particular attention to cords at plugs, convenience receptacles, and the point where they exit from the product.

OUTDOOR ANTENNA GROUNDING — If an outside antenna or cable system is connected to the product, be sure the antenna or cable system is grounded so as to provide some protection against voltage surges and built-up static charges. Article 810 of the National Electrical Code, ANSI/NFPA 70, provides information with regard to proper grounding of the mast and supporting structure, grounding of the lead-in wire to an antenna discharge unit, size of grounding conductors, location of antenna-discharge unit, connection to grounding electrodes, and requirements for the grounding electrode. See Figure A.

LIGHTNING — For added protection for this product during a lightning storm, or when it is left unattended and unused for long periods of time, unplug it from the wall outlet and disconnect the antenna or cable system. This will prevent damage to the product due to lightning and power-line surges.

POWER LINES — An outside antenna system should not be located in the vicinity of overhead power lines or other electric light or power circuits, or where it can fall into such power lines or circuits. When installing an outside antenna system, extreme care should be taken to keep from touching such power lines or circuits as contact with them might be fatal.

OVERLOADING — Do not overload wall outlets, extension cords, or integral convenience receptacles as this can result in a risk of fire or electric shock.

OBJECT AND LIQUID ENTRY — Never push objects of any kind into this product through openings as they may touch dangerous voltage points or short-out parts that could result in a fire or electric shock. Never spill liquid of any kind on the product.

SERVICING — Do not attempt to service this product yourself as opening or removing covers may expose you to dangerous voltage or other hazards. Refer all servicing to qualified service personnel.

DAMAGE REQUIRING SERVICE — Unplug this product from the wall outlet and refer servicing to qualified service personnel under the following conditions:

- When the power-supply cord or plug is damaged.
- If liquid has been spilled, or objects have fallen into the product.
- If the product has been exposed to rain or water.
- If the product does not operate normally by following the operating instructions. Adjust only those controls that are covered by the operating instructions as an improper adjustment of other controls may result in damage and will often require extensive work by a qualified technician to restore the product to its normal operation.
- If the product has been dropped or damaged in any way.
- When the product exhibits a distinct change in performance — this indicates a need for service.

REPLACEMENT PARTS — When replacement parts are required, be sure the service technician has used replacement parts specified by the manufacturer or have the same characteristics as the original part. Unauthorized substitutions may result in fire, electric shock, or other hazards.

SAFETY CHECK — Upon completion of any service or repairs to this product, ask the service technician to perform safety checks to determine that the product is in proper operating condition.

WALL OR CEILING MOUNTING — The product should not be mounted to a wall or ceiling.

HEAT — The product should be situated away from heat sources such as radiators, heat registers, stoves, or other products (including amplifiers) that produce heat.

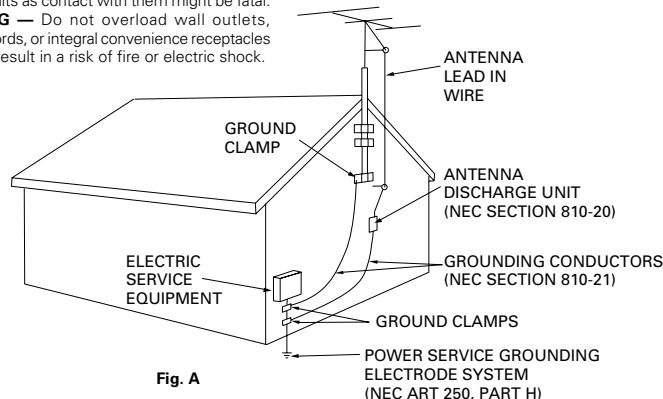

Fig. A

NEC — NATIONAL ELECTRICAL CODE

This equipment has been tested and found to comply with the limits for a Class B digital device, pursuant to Part 15 of the FCC Rules. These limits are designed to provide reasonable protection against harmful interference in a residential installation. This equipment generates, uses, and can radiate radio frequency energy and, if not installed and used in accordance with the instructions, may cause harmful interference to radio communications. However, there is no guarantee that interference will not occur in a particular installation. If this equipment does cause harmful interference to radio or television reception, which can be determined by turning the equipment off and on, the user is encouraged to try to correct the interference by one or more of the following measures:

- Reorient or relocate the receiving antenna.
- Increase the separation between the equipment and receiver.
- Connect the equipment into an outlet on a circuit different from that to which the receiver is connected.
- Consult the dealer or an experienced radio/TV technician for help.

Information to User

Alteration or modifications carried out without appropriate authorization may invalidate the user's right to operate the equipment.

CAUTION

- Use of controls or adjustments or performance of procedures other than those specified herein may result in hazardous radiation exposure.
- The use of optical instruments with this product will increase eye hazard.

[For Canadian model]

This Class B digital apparatus meets all requirements of the Canadian Interference-Causing Equipment Regulations.

[Pour le modèle Canadien]

Cet appareil numérique de la Classe B respecte toutes les exigences du Règlement sur le matériel brouilleur du Canada.

Disc Types Compatible with This Unit

This player is DVD, CD, and Video CD compatible.

The marks shown below are found on disc labels or on disc jackets.

- This player can play all discs bearing the marks below without the need for an adaptor.
- To prevent malfunction, do not use an 8 cm (3 in.) adaptor (for CDs).

This unit is NTSC compatible (the U.S. and Canadian TV system). You cannot use discs other than those shown below.

Types of playable discs and their marks	Diameter/Playable sides	Playback time
	DVD VIDEO*	Digital audio Digital video (MPEG 2)
	12 cm (5in.)/ single-sided	1 layer 2 layer 133 min. (4.7 GB) 242 min. (8.5 GB)
	12 cm (5in.)/ double-sided	1 layer 2 layer 266 min. (9.4 GB) 484 min. (17GB)
	DVD VIDEO*	Digital audio Digital video (MPEG 2)
	8 cm (3 in.)/ single-sided	1 layer 2 layer 41 min. 75 min.
	8 cm (3 in.)/ double-sided	1 layer 2 layer 82 min. 150 min.
VIDEO CD 	VIDEO CD	Digital audio Digital video (MPEG 1) Max. 74 minutes
	12 cm (5 in.)/single-sided	
	VIDEO CD single	Digital audio Digital video (MPEG 1) Max. 20 minutes
	8 cm (3 in.)/single-sided	
CD 	CD	Digital audio Max. 74 minutes
	12 cm (5 in.)/ single-sided	
	CD single	Digital audio Max. 20 minutes
	8 cm (3 in.)/ single-sided	

Discs other than the ones indicated above cannot be played on this unit.

To avoid damage etc., do not play any discs other than those indicated above.

Ex: DVD-Audio, DVD-ROM, CD-ROM, DVD that has a different region No. than this unit, etc. (Refer to "Terms" on page 57)

About disc composition

CD and Video CD discs are divided into units referred to as tracks. (Generally, 1 song corresponds to 1 track. Additionally, some tracks are divided into units referred to as indexes.)

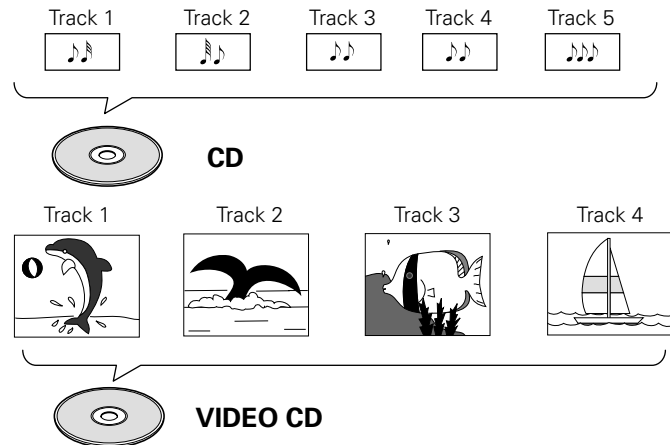

DVD discs are divided into units referred to as titles, and these titles are divided into chapters. Additionally, menu screens do not belong to any title. Usually for movies etc., 1 movie corresponds to one title. On Karaoke discs, 1 song has 1 title. It is not uncommon, however, for discs to have a unique title division, and it should be noted that search and program modes may be affected in these cases.

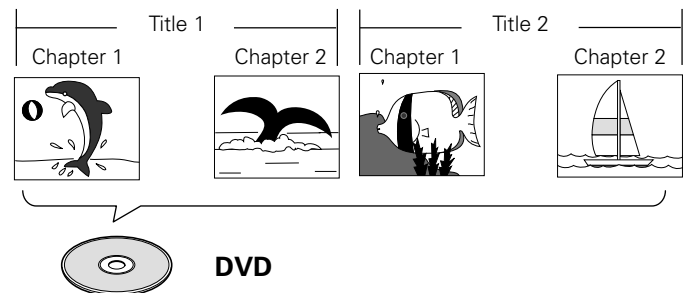

About disc operation

On some DVD discs, operation methods may change or specific operations may be prohibited according to the intentions of the disc's manufacturer. Because of this, operation methods may differ depending on the disc, or some specific functions may not be operable. When operation of a function prohibited by the disc is attempted on a PIONEER DVD player, a prohibited mark will be displayed on the screen. Additionally, on discs where interactive operation is possible through menu operation or through operation during playback, because discs are not completely continuous, but rather divided into sections, some operation for functions such as repeat or programming etc., may not be possible. On PIONEER DVD players, a prohibited mark will be displayed on the screen in these instances.



See What You Can Do

DVD, VideoCD (PBC compatible) and CD discs can be played back on PIONEER DVD players

Compatible with a wide range of DVD audio output

DVD discs are recorded in one of the following 4 types of digital audio formats (as of July 1998). The digital audio output jacks of this player output any of the following digital audio signals.

- **DOLBY DIGITAL***
Surround system for theaters. By connecting this unit to a Dolby Digital decoder or an AV amplifier with a built-in Dolby Digital decoder, DVD discs recorded in Dolby Digital audio can be played back in Dolby Digital surround sound.
- **DTS****
Surround standard different from Dolby Digital. This format is already in use in many theaters. By connecting this unit to a DTS decoder or an AV amplifier with a built-in DTS decoder, the DTS audio of DVD discs recorded in this format can be enjoyed. However, audio will not be output from the analog audio output jacks.
- **MPEG**
By connecting this unit to an MPEG decoder or an AV amplifier with a built-in MPEG decoder, the MPEG audio of DVD discs recorded in this format can be enjoyed.
- **Linear PCM**
Same digital audio format as on CDs. Digital audio can be enjoyed by connecting this unit to an amplifier with a built-in D/A converter. Additionally, 2 channel analog audio is output from the audio output jacks.

This player has a conversion function for converting Dolby Digital and MPEG audio into the Linear PCM format. This allows playback of CDs with the regular playback system without the need for a special convertor.

3-dimensional audio with 2 front speakers (page 38)

Setting the Virtual Dolby Surround mode to "VDD" or "VDS" creates a 3-dimensional sound without the need for surround speakers.

Frequencies above 20KHz will be reproduced with master like quality as natural wave forms (Legato Link conversion)

Legato Link conversion estimates recording signals according to the original I/f attenuation characteristic in order to reproduce frequency component of signals that are not recorded in the frequency band of the format (above 20kHz). Wave form sound very close to the original is created for audio reproduction.

Operation while viewing menu screens (GUI: Graphical User Interface) (page 30)

DVDs come recorded with their own original menus. These menus are operated with the direction buttons. With the PIONEER player, the player's menus can be used for operation even with discs that have not been recorded with menus.

* *Manufactured under license from Dolby Laboratories. "Dolby", "AC-3" and the double-D symbol are trademarks of Dolby Laboratories. Confidential Unpublished Works, © 1992-1997 Dolby Laboratories, Inc. All rights reserved.*

** *"DTS" is trademark of Digital Theatre Systems, Inc.*

This product incorporates copyright protection technology that is protected by method claims of certain U. S. patents and other intellectual property rights owned by Macrovision Corporation and other rights owners. Use of this copyright protection technology must be authorized by Macrovision Corporation, and is intended for home and other limited viewing uses only unless otherwise authorized by Macrovision Corporation. Reverse engineering or disassembly is prohibited.

See What You Can Do

☆ For some discs, the function is impossible.

A wide range of DVD features are available for your enjoyment

- Multiple Languages (page 40) ☆
With discs that have multiple language soundtracks recorded on them, you can select the desired language.

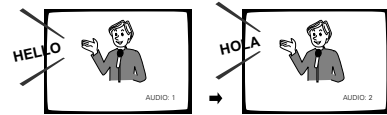

- Multi-Language Subtitles (page 41) ☆
You can select a desired subtitle language when watching movies and other videos.

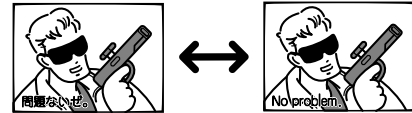

- Multi-Aspect (page 34) ☆
For this discs with wide screen format, the screen size can be selected from among the wide, Letter Box and Pan & Scan formats.



- Multi-Angle (page 41) ☆
Lets you view scenes from different camera angles.

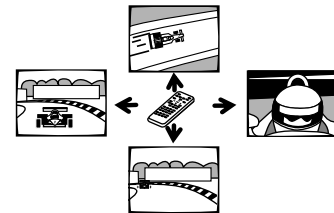

- Parental Level (page 32) ☆
Lets you select a "parental level" (user restriction level) to prevent children from viewing undesirable material.

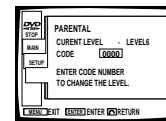

- Picture quality adjustment function (DNR) (page 36) ☆
Picture quality can be adjusted according to the disc being played.

Energy-Saving Design

- This unit is designed to use minimal electricity when power is switched standby (during standby).
- Regarding the value of the power consumption in standby mode, refer to "Specifications" on page 60.

How to use this operating instructions

Explanations in this manual are grouped into the following 5 sections:

Preparation	This section explains accessory part confirmation, how to load batteries in the remote control unit, and how to make connections.
Basic Operation	This section explains basic functions such as playback and shutdown.
Set-up	This section explains a wide range of functions related to basic system operations.
Detailed Operation	This section explains applied operations such as program setup, repeat playback etc.
Others Information	This section explains other important items concerning this player.

The following logo marks are used throughout this manual.

	Indicates explanations concerning DVD functions.
	Indicates explanations concerning CD functions.
	Indicates explanations concerning VideoCD functions.
	Indicates important points concerning operation of this unit.
	Indicates explanations of precautions concerning operation of the unit.
	Indicates suggestions and other supplementary explanations.

Contents

Preparation

Connecting the Player	Connection example 1. AV amp
	Connection example 2. AV amplifier with digital input for Dolby Digital (AC-3)
	Connection example 3. Digital recording components
	Connection example 4. To a TV with video input
	Connection example 5. To a TV with component video input
Names and Functions	Remote Control
	Front Panel
	Rear Panel
	Display Window

Basic Operation

Playing DVDs, CDs and Video CDs
Chapter (Track) Skip/Skip Back
Stopping Playback & Switching Power OFF

Set-Up

About the main menu
Changing Settings
Changing Picture and Sound Quality
Memorizing Settings for Often Viewed DVDs (Condition Memory)
Selecting Languages (Multi-Language)
Changing Audio Type
Selecting Subtitle a Language (Multi-Language Subtitles)
Viewing from a Desired Camera Angle (Multi-Angle)
Viewing Disc Information

Detailed Operation

Continuing Playback from Where You Stopped
Searching For a Desired Video Scene (Title search)
Searching for a Desired Video Scene/Audio Track (Chapter/Track Search)
Playback in a Desired Order (Program Play)
Repeat Play
Still Frame/Slow Play/Frame Advance
Random Play

Other Information

For Proper and Long Use
Troubleshooting
Terms
Language Code List
Specifications

Applicable discs

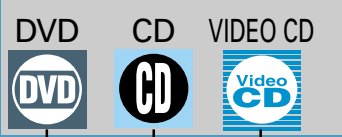

15
16
17
18
19
20
21
21
22

24
25
26

28
31
36
39
40
40
41
41
42

44
45
46
47
50
51
52

53
54
56
58
60

Preparation

Basic
Operation

Setup

Detailed
Operation

Other
Information

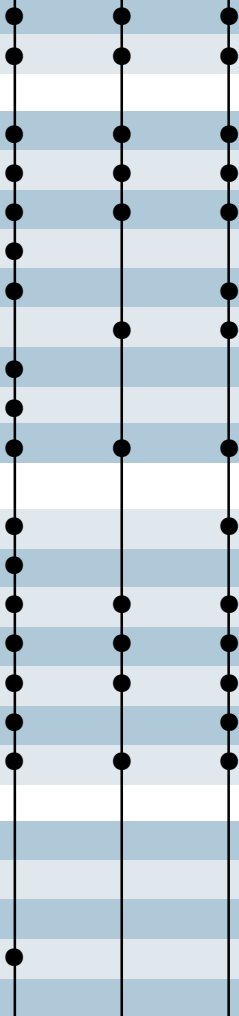

Introduction

THX



With their experience in movie making and DVD mastering, Lucasfilm engineers researched the capabilities of the DVD format. They have identified many key areas of importance that are necessary to ensure the highest quality possible for video and audio playback.

The Home THX DVD specification was created to realize the full potential of the format. The THX DVD program is a number of technical and performance specifications developed to make certain that the audio and video quality of every DVD recording is reproduced as accurately as possible. Thus exploiting the medium's maximum potential.

Pioneer and THX have engineered this product to give maximum performance and quality.

Manufactured under license from Lucasfilm Ltd. Lucasfilm and THX are trademarks of Lucasfilm Ltd.

Before Using

Check accessories

Audio cord

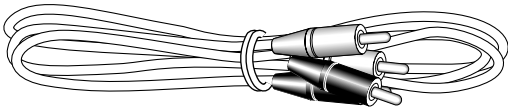

Video cord

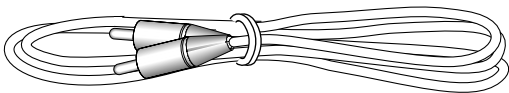

Power cord

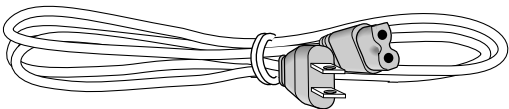

Remote control unit

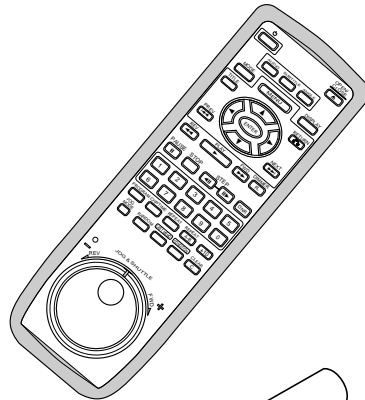

Batteries ... 2
(AA/R6P)

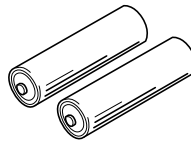

Other included items:

- Warranty card
(Region number ① models only.)
- Operating Instructions
(this manual)

Inserting batteries into the remote control

1

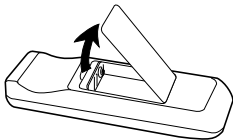

While pressing the back cover, pull out in the direction indicated by the arrow.

2

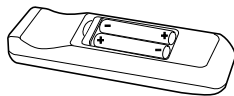

Insert batteries.

Make sure to match the plus (+) and minus (-) polarity guides on the batteries with the marks inside the battery compartment.

3

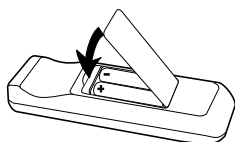

Close the cover.

Note

- ◆ Do not mix old and new batteries.
- ◆ When replacing batteries, use all new batteries.
- ◆ When not using the remote control for a long period of time (over 1 month), remove the batteries to avoid possible damage from battery corrosion. If battery leakage occurs, wipe the battery liquid from the battery component, then insert new batteries.

Preparation

Connecting the Player

Connection example 1. AV amp	15
Connection example 2. AV receiver with digital input for Dolby Digital (AC-3)	16
Connection example 3. Digital recording components	17
Connection example 4. To a TV with Video input	18
Connection example 5. Digital recording components	19

Names and Functions

Remote control	20
Front panel	21
Rear panel	21
Display window	22

Precautions when connecting the player

This player's Analog copy protect technology is copy guarded. If you connect the player to a TV via a VCR, or record and playback the contents of a disc with a VCR, the playback picture may not be normal.

- The video output system on this unit can be widely separated into two types.
1. S-Video output and VIDEO output (connection example 1, 2, 4)
 2. Component video output (connection example 5)

Connecting the Player

When making connection, to this unit or when changing connections, always be sure to check that the unit in standby by pressing the STANDBY/ON switch, and unplug the power cord from the power outlet.

Please also refer to the operating instructions for the components that you are connecting to (AV amplifier, TV etc.).

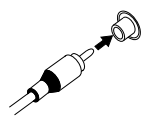
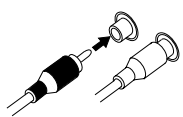
<p>Video out (Video cord) Coaxial digital out (Coaxial cable)</p> 	<p>Audio out (Audio cord)</p> 
<ul style="list-style-type: none"> Connect plugs to the terminals that match the plug's color (white, red, yellow, and black). 	

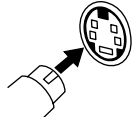
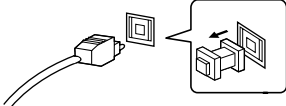
<p>S-Video out (S-Video cable)</p> 	<p>Optical digital out (Optical fiber cable)</p> 
<ul style="list-style-type: none"> Connect the TV with S-VIDEO terminal to the S VIDEO OUT terminal of this player. 	

- Connection cords that we recommend be connected are indicated in grey tone (■). If you cannot use the connection cords we recommend, use the light grey tone (□) cords.
- As DVDs have various audio formats depending on the disc, after making connections, use the menu on this unit to set the output to the setting that matches the disc. (Page 35)
- Connection method will differ depending on the components being connected. Select the component that you are connecting from the list below.

Component being connected to this unit	Connection example reference	Output setup on this unit (This list is for changing the setting of initial setup. For details refer to page 35.)
AV amplifier with built-in Dolby Digital decoder	Connection example 1 (Page 15)	Initial setting is left as is
AV amplifier with built-in DTS decoder	Connection example 1 (Page 15)	Set DTS ON
AV amplifier with built-in MPEG decoder	Connection example 1 (Page 15)	MPEG
AV amplifier with built-in D/A convertor	Connection example 2 (Page 16)	DOLBY DIGITAL → PCM
Amplifier other than those above or stereo amplifier	Connection example 2 (Page 16)	Initial setting is left as is
Digital recording component such as MD or CD-R etc.	Connection example 3 (Page 17)	DOLBY DIGITAL → PCM, MPEG → PCM
TV with video input	Connection example 4 (Page 18)	Initial setting is left as is
TV with component input	Connection example 5 (Page 19)	Initial setting is left as is

Connection example 1.

AV amplifier with built-in decoder
 Use this connection to connect an:

- AV amplifier with built-in Dolby Digital (AC-3) decoder
- AV amplifier with built-in DTS decoder AV
- AV amplifier with built-in MPEG decoder, etc.

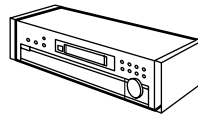

When connecting to the digital inputs of an AV amplifier with built-in decoder.

- Connect the digital output jacks of this player to the digital input jacks (Dolby Digital (AC-3), DTS, MPEG) of the decoder included AV amplifier.
- Set the DIG. OUTPUT on the menu during stop mode to match the connected AV amplifier. (Page 35)

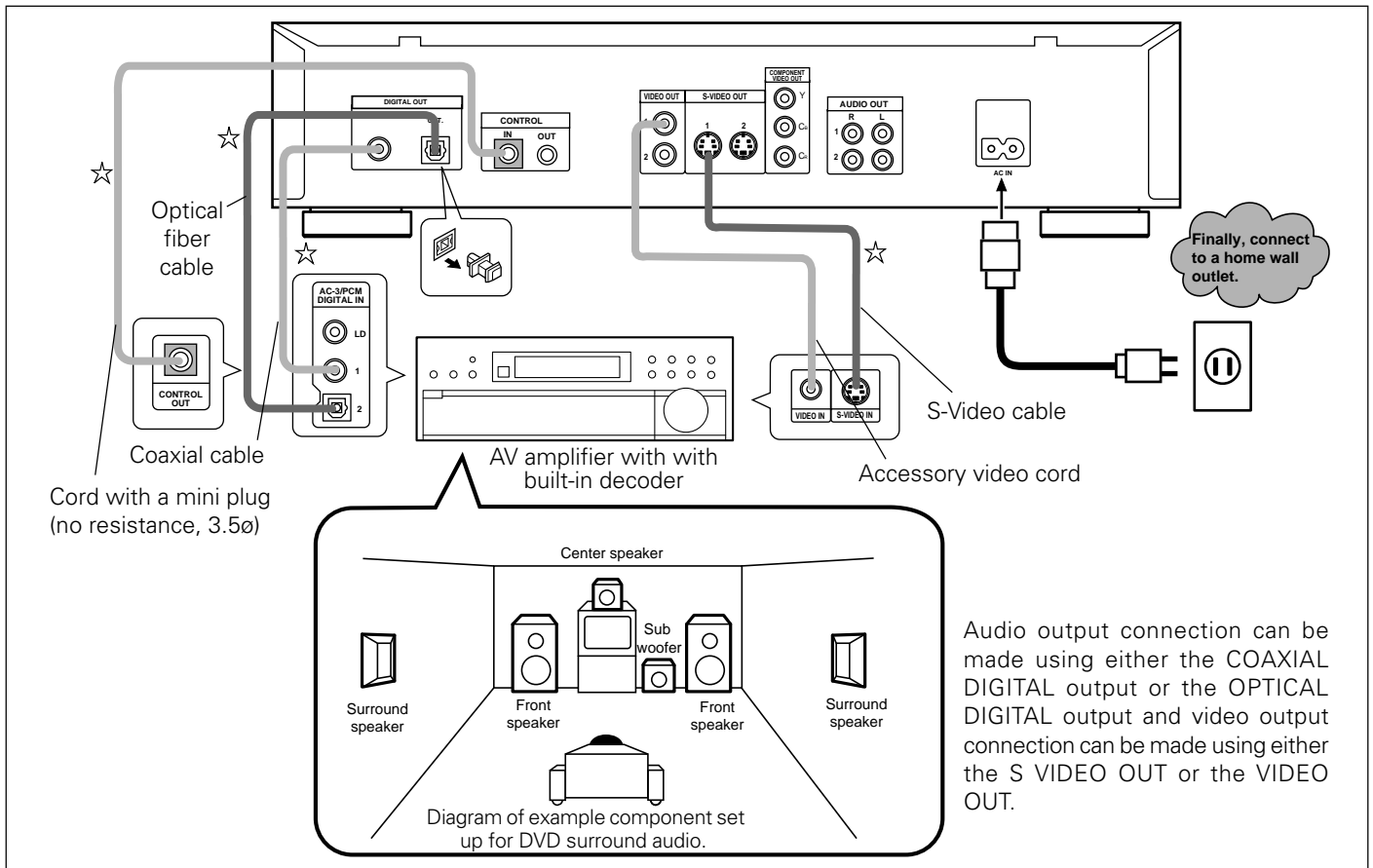

- **When connecting to a component bearing the Pioneer SR mark:**
 If you use a commercially available cord with a mini plug (no resistance) to connect this player's CONTROL IN jack to the CONTROL OUT jack of another component bearing the SR mark, you can control the player as though it were a component in a system (system control).
- If you connect for system control, you cannot operate the player directly by pointing the remote control at it and pressing buttons. Point the remote control unit at the component (AV amplifier etc.) connected to the CONTROL OUT jack for operation.
- When controlling as a system, **be sure to make connection to the amplifier using an audio cord or a video cord even when using only digital components.**
- For more details, refer to the connected component's operating instructions.

Note

☆ Cables can be found at your local audio/video dealer. There will be no sound output from the AUDIO OUT jacks during DTS audio playback.

Connecting the Player

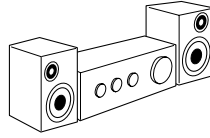

Connection example 2. AV amplifier without built-in decoder

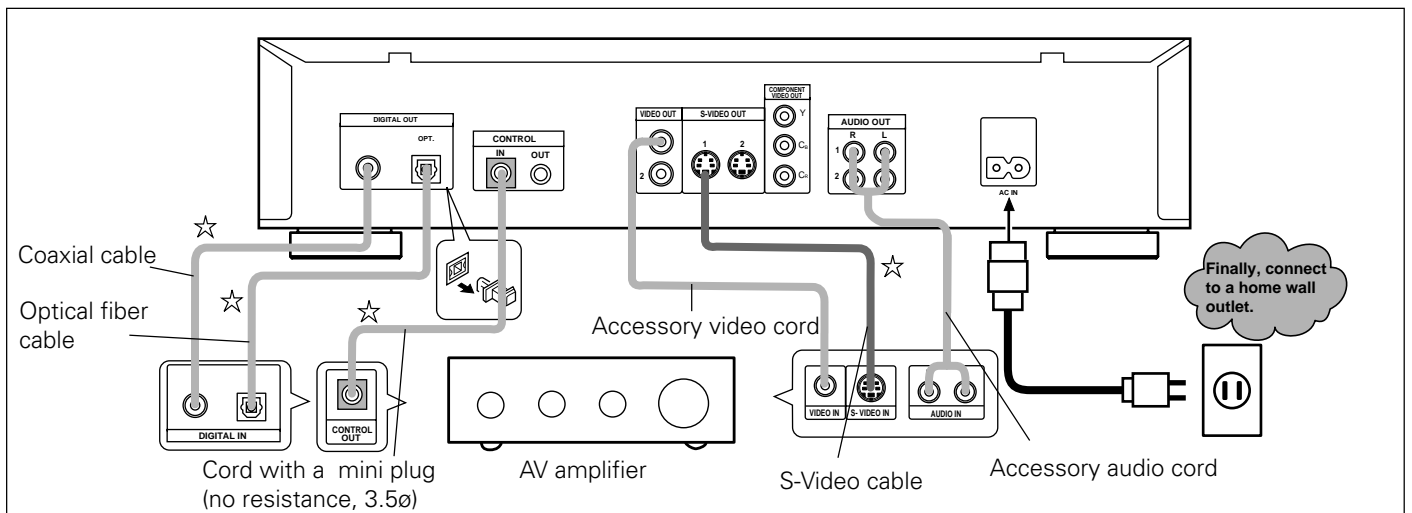

By connecting to a regular AV amplifier or stereo amplifier, you can enjoy playback with improved sound quality.

- Connect this player's audio output jacks to an amp's CD, LD, AUX or other audio input jacks. (Do not connect to PHONO jacks.)
- For video output, connect this unit's video output to the amplifier's video input. Either the S-VIDEO OUT jack or VIDEO OUT jack can be used for connection. Digital output connection can be made using either the COAXIAL DIGITAL output or the OPTICAL DIGITAL output.
- Surround sound can be enjoyed with amplifiers that have a built-in Dolby Pro Logic decoder.



- **When connecting to a component bearing the Pioneer  mark:**
If you use a commercially available cord with a mini plug (no resistance) to connect this player's CONTROL IN jack to the CONTROL OUT jack of another component bearing the  mark, you can control the player as though it were a component in a system (system control).
- If you connect for system control, you cannot operate the player directly by pointing the remote control at it and pressing buttons. Point the remote control unit at the component (AV amplifier etc..) connected to the CONTROL OUT jack for operation.
- When controlling as a system, **be sure to make connection to the amplifier using an audio cord or a video cord, even when using only digital components.**
- For more details, refer to the connected component's operating instructions.

Note

☆ Cables can be found at your local audio/video dealer.

Connection example 3.

Digital recording components

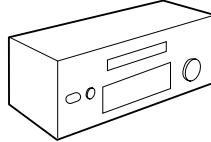

Digital recording components such as an MD, CD-R or DAT can be connected.

Make either optical digital or digital output (Coaxial) connection.

- When making optical digital connection, connect this unit's optical digital output jack to the optical digital input jack on the recording component.
- When making coaxial digital connection, connect this unit's coaxial digital output jack to the coaxial digital input jack on the recording component.

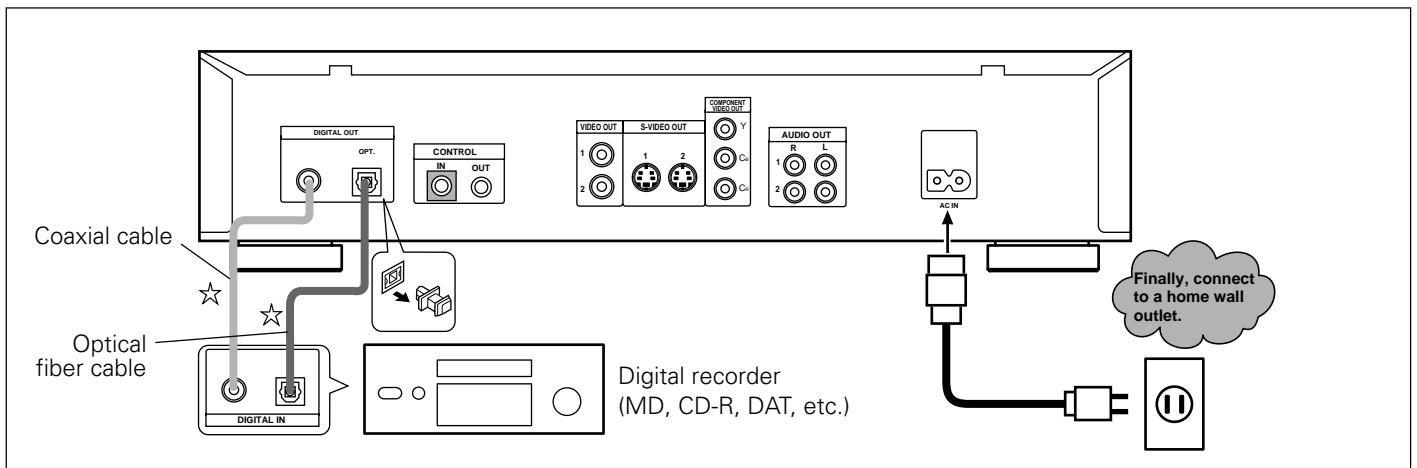

Note

When recording a Dolby Digital compatible DVD, set the "DOLBY DIGITAL" setting of "DIGITAL OUTPUT" to "DOLBY DIGITAL → PCM". (Page 35)

Also, when recording an MPEG compatible DVD, set "MPEG" of "DIGITAL OUTPUT" to "MPEG → PCM". When the DVD has been recorded in the Dolby Digital (AC-3) or MPEG format, leaving the setting as "DOLBY DIGITAL" or "MPEG" will result in noise being recorded. Additionally, copying of some discs is prohibited.

☆ Cables can be found at your local audio/video dealer.

Connecting the Player

Select one of the following ways to connect the player to your TV.

Connection example 4.

To a TV with video input

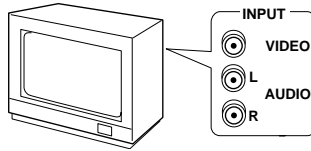

If your TV has a video input, and it is available for use, this is the easiest way to hook up the player.

- Connect plugs to the terminals that match the plug's color (white, red, yellow).
- Clearer picture reproduction is possible by connecting the TV's S-Video input terminal to this unit's S-VIDEO OUT jack.

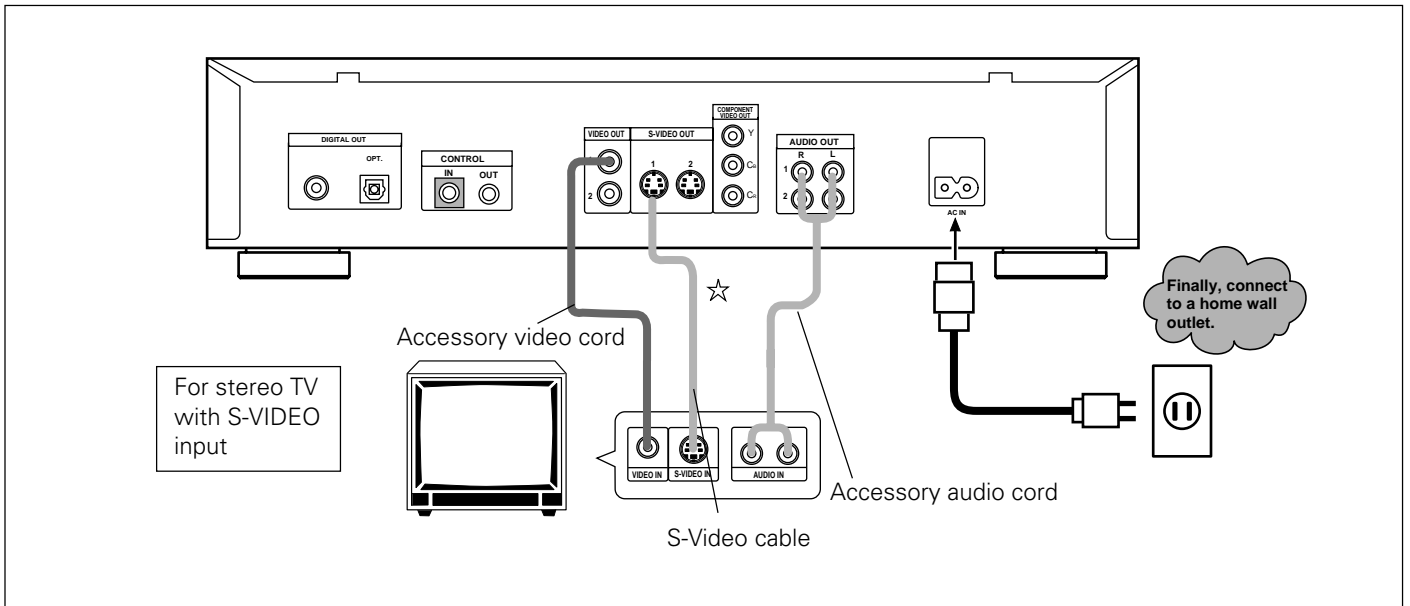

Note

☆ Cables can be found at your local audio/video dealer.

Connection example 5.
To a TV with component video input

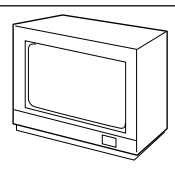

A better picture can be viewed using a TV that has a component video input.

- When this unit is combined with a TV that has component jacks, they can be used for video input. This produces higher quality picture playback.
- Names of component input jacks will differ depending on the TV.
- If picture color becomes pale or hue changes, please make adjustment with the TV's controls.

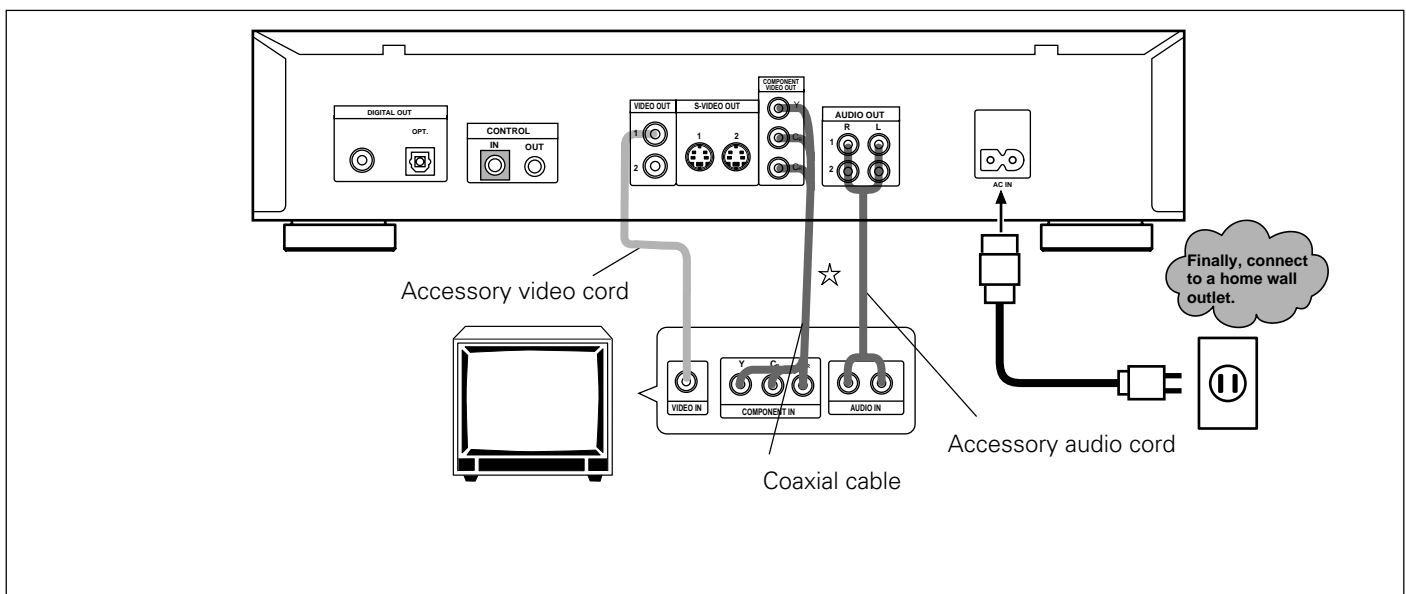

Note

☆ Cables can be found at your local audio/video dealer.

Names and Functions

Remote control

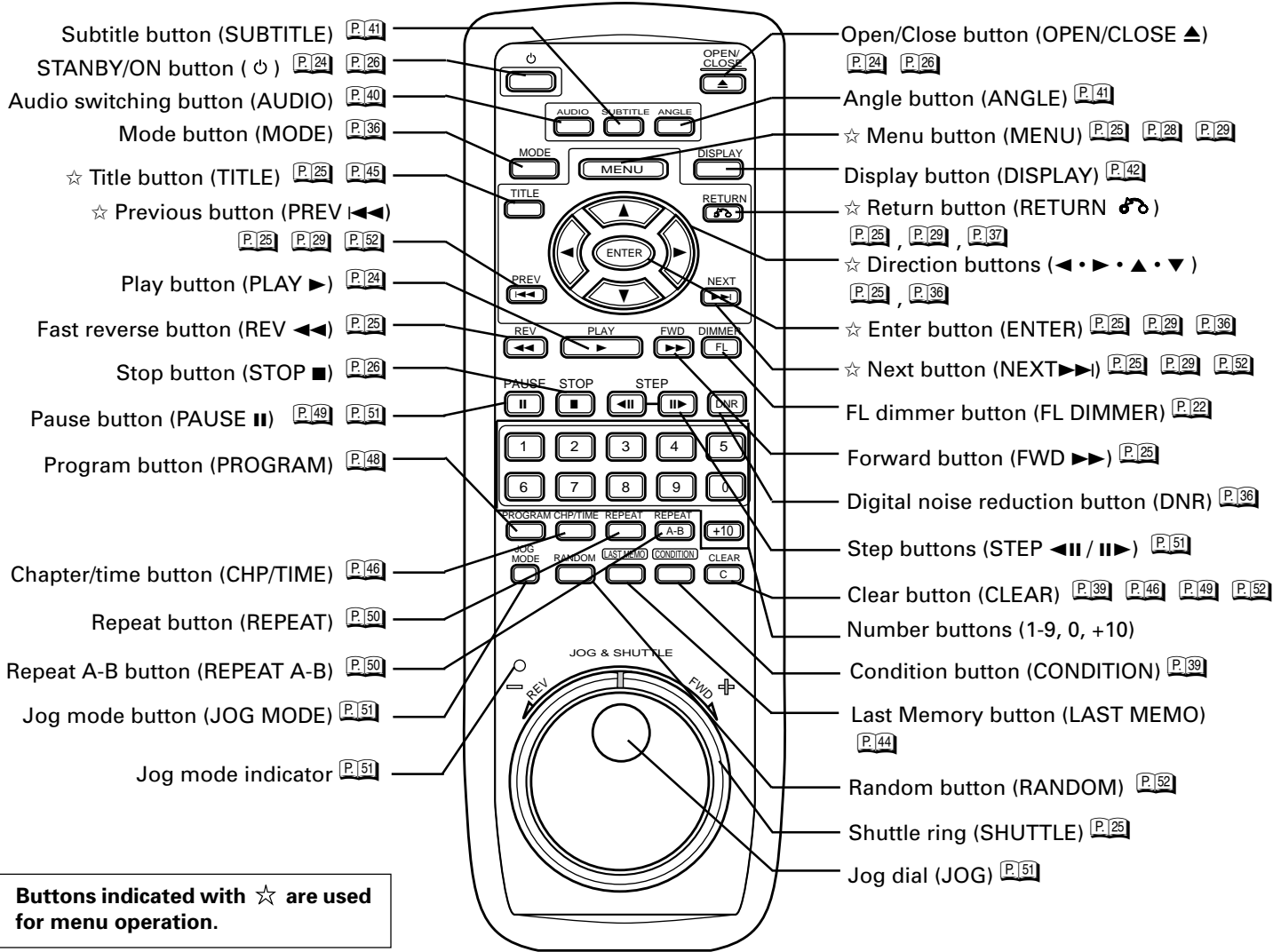

Remote control operation

When operating the remote control, point it at the remote sensor located on the player's front panel. The remote control can be used up to 23 feet (7 m) from the player and within a 30° angle each side of the sensor.

- Exposing the remote sensor to direct sunlight or strong light may cause faulty operation.
- If the CONTROL IN jack on the player's rear panel is connected to another component, point the remote control at that component for operation. Operation is not possible when pointed at this player (Pages 15,16).

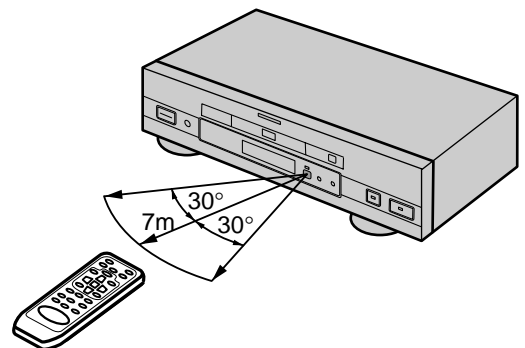

Front panel

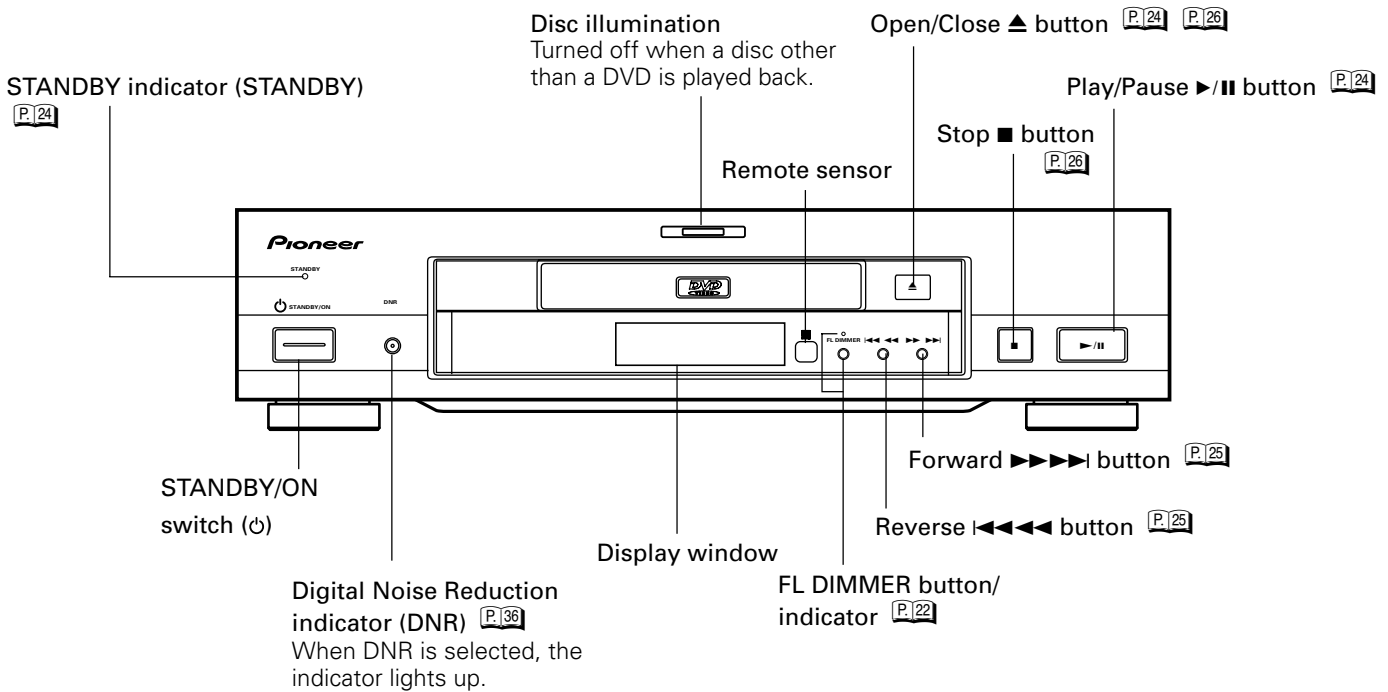

Rear panel

Digital Output Jacks (Coaxial, Optical)

This is used for output of the digital audio signal recorded on discs.
Set digital output to the setting suitable for the amplifier used. (Page 35).

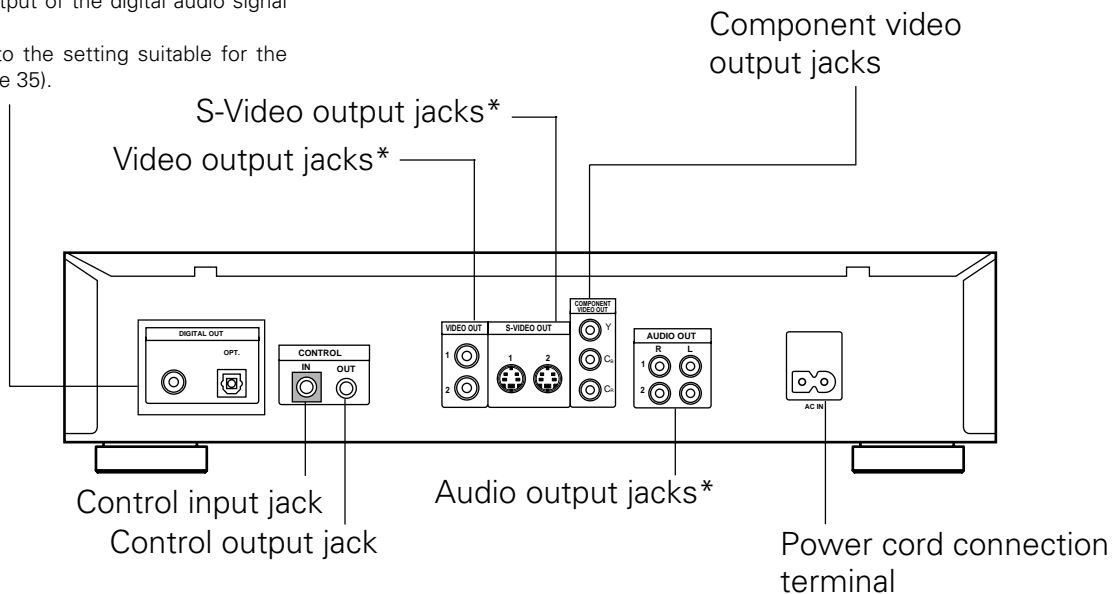

* There are two sets of outputs, 1 and 2, which you can simultaneously connect. Connect 1 to the TV, and 2 to your AV amplifier.

Preparation

Basic Operation

Setup

Detailed Operation

Other Information

Display window

When the FL DIMMER button is pressed, the FL display's brightness changes as follows:
 Bright → Dim → Dark → FL OFF

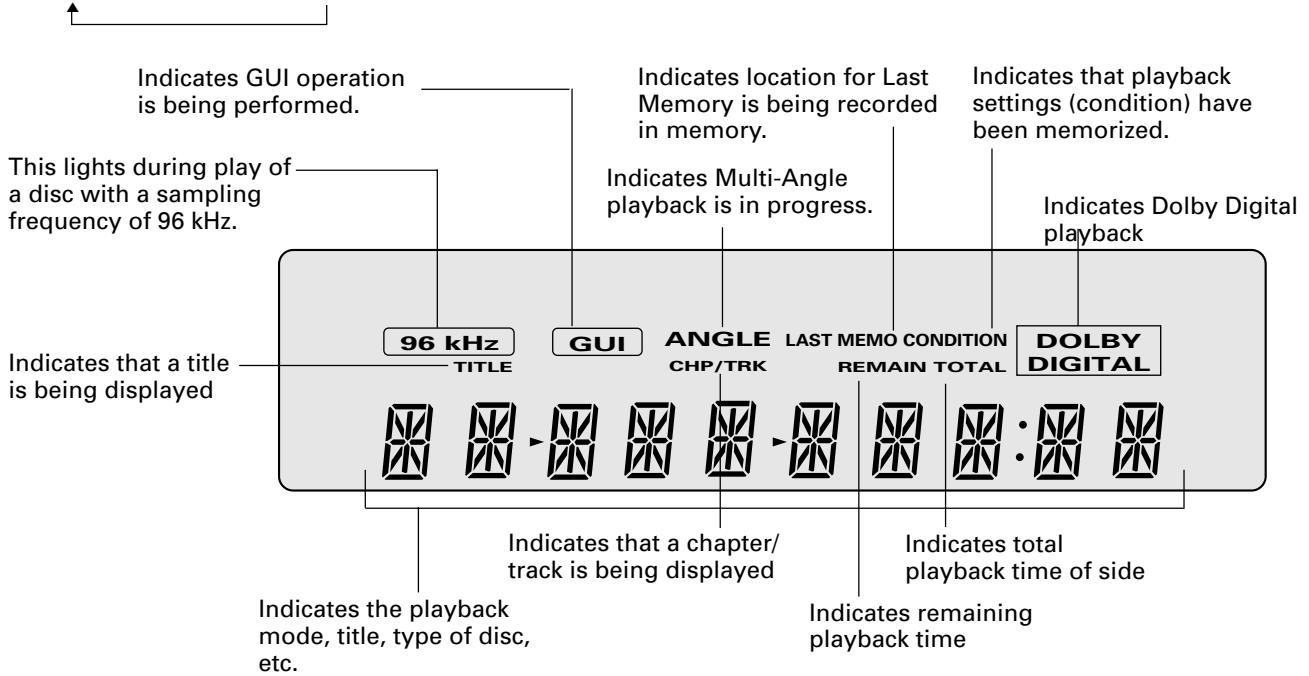

Basic Operation

Playing DVDs, CDs and Video CDs.....	24
Chapter (Track) Skip/Skip Back	25
Stopping Playback & Switching Power OFF	26

Playing DVDs, CDs and Video CDs



- Turn the TV's power on and set its input to a position for DVD viewing (VIDEO etc.).
- When this unit is connected to a stereo, turn the power of the stereo's components on.

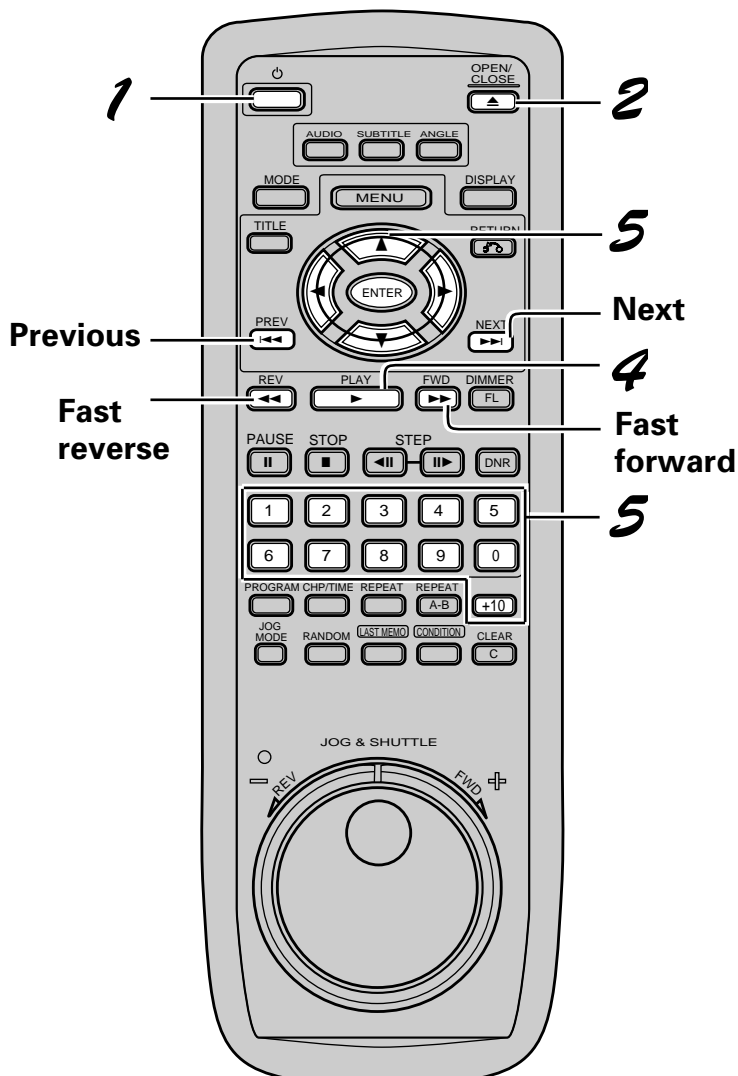
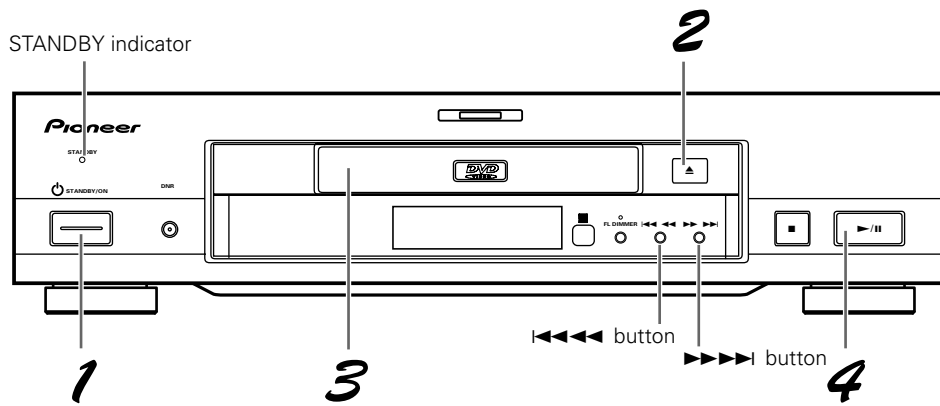

1 Press the **STANDBY/ON** button.

- The STANDBY indicator on the player turns off.

2 Press the **OPEN/CLOSE** button.

- Press the **▲** button on the front of the player.
- The disc table comes out.

3 Load a disc.

- Load a disc with the label side facing up, using the disc table guide to align the disc.

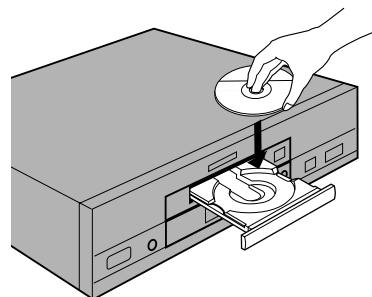

4 Press the **PLAY** button.

- Press the **▶/||** button on the front of the player.
- The disc table will close, and playback will begin.
- Depending on the disc, a menu is displayed. If a menu is displayed, refer to step 5.

Chapter (Track) Skip Forward/Skip Back

When a menu screen has been displayed

- Operate with the remote control unit.
Menu screens will be displayed for DVDs that have menu screens or Video CDs that include Playback Control (PBC).

Ex: When a DVD that has menu screens is loaded

Ex: When a Video CD that includes Playback Control is loaded

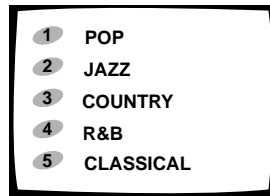
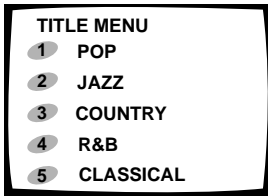

Please note that menu layout and operation method will differ according to the disc used.

5 Select the item you want to view.

- When a DVD is loaded
Select the item with the direction buttons (◀•▶•▲•▼), then press the **ENTER** button.
- When a Video CD is loaded
Use the number buttons to select the item.

Tips

- Video CDs can be played back without display MENU**
Video CDs can be played back without displaying menu screens. For example, in order to play back from track 1, press number button 1 during the stop mode.



- To return to the menu screen**
Although this differs depending on the disc, pressing the TITLE button, the MENU button or the RETURN button during DVD playback or the RETURN button during VideoCD playback will return the screen to the menu screen.
- When the Video CD has more than one menu, pages can be advanced to or returned to with the PREV button or the NEXT button.

Skipping forward to the next chapter (track)

Press the **NEXT** ▶▶▶ button (The ▶▶▶ button on the front panel).

- Press to skip forward to the next chapter (track).
- Press again to skip forward to the start of the next chapter (track).

Skipping back to the previous chapter (track)

Press the **PREV** ◀◀◀ button (The ◀◀◀ button on the front panel).

- Press once to skip back to the start of the chapter (track) currently playing.
- Press again to skip back to the start of the previous chapter (track).

Fast forward

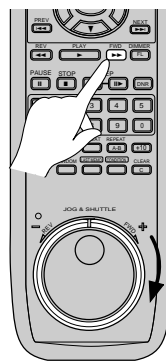

Continue pressing the **FWD** ▶▶▶ button.

- If you stop pressing while the on-screen "SCAN" indication is flashing, normal play resumes.
- If the "SCAN" indication lights, fast forward continues even if you stop pressing the button. Press the **PLAY** ▶ button to resume normal play when you reach your desired location.
- Continue pressing the **FWD** ▶▶▶▶▶ button on the player to fast forward.

Turn the shuttle to the right.

- Depending on the amount the ring is turned, the speed will change from the normal speed up to approx. 30 times higher than normal speed. Releasing the ring will return playback to the normal speed.

Fast reverse

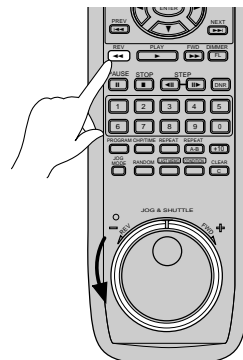

Continue pressing the **REV** ◀◀◀ button.

- If you stop pressing while the on-screen "SCAN" indication is flashing, normal play resumes.
- If the "SCAN" indication lights, fast reverse continues even if you stop pressing the button. Press the **PLAY** ▶ button to resume normal play when you reach your desired location.
- Continue pressing the **REV** ◀◀◀◀◀ button on the player to fast reverse.

Turn the shuttle to the left.

- Depending on the amount the ring is turned, the speed will change from the normal speed up to approx. 30 times higher than normal speed. Releasing the ring will return playback to the normal speed.

Stopping Playback & Switching Power Off

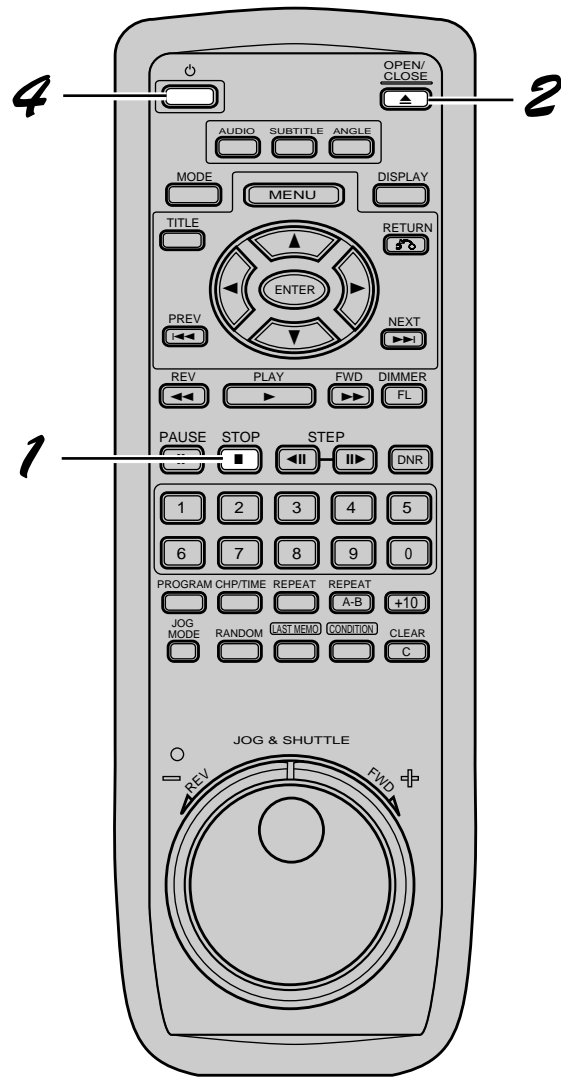
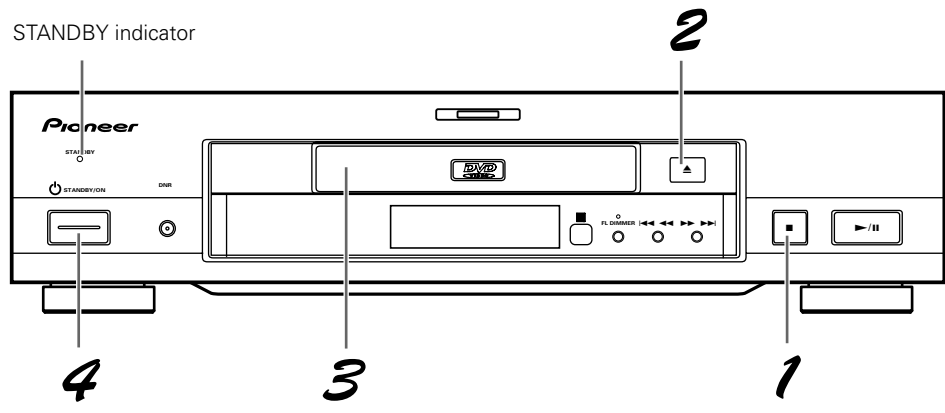

- 1** Press the STOP ■ button.
 - Playback stops.
- 2** Press the OPEN/CLOSE ▲ button.
 - The disc table comes out.
- 3** Remove the disc.

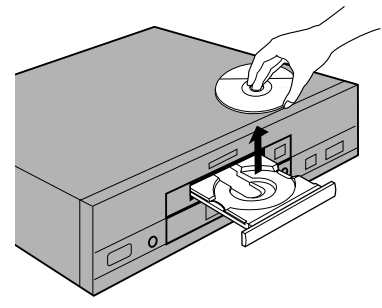

- 4** Press the ⏻ STANDBY/ON button.
 - When the ⏻ STANDBY/ON button is pressed, the disc table goes back in, and the STANDBY indicator lights up.

Set up

About the main menu	28
Changing Settings	31
Changing Picture and Sound Quality	36
Memorizing Settings for Often Viewed DVDs (Condition Memory)	39
Selecting Languages (Multi-Language)	40
Changing Audio Type.....	40
Selecting a Subtitle Language (Multi-Language Subtitles)	41
Viewing from a Desired Camera Angle (Multi-Angle)	41
Viewing Disc Information	42

About the main menu

The main menu is the menu used for selecting the Title menu screen, Menu screen and Set up screen. Load a DVD in the disc tray and press MENU. (On discs that start playing back automatically, press the STOP button and then press the MENU button.)

DVD

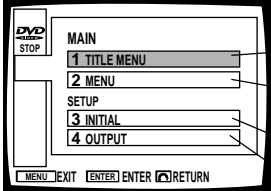

In the Title menu screen:
Titles can be selected and played back. (Title search)

CD or Video CD

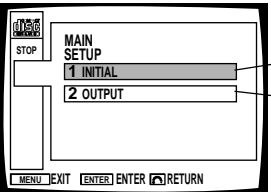

In the Menu screen:
Chapters (songs), subtitles, audio and angles within a title can be selected.

In the Initial setup screen:
The various functions of this player can be set up using the screen displays.

In the Output setup screen:
Audio to be output from the digital output terminal can be selected.

● On discs recorded with menus, menu operation will differ depending on the disc.

About the title menu

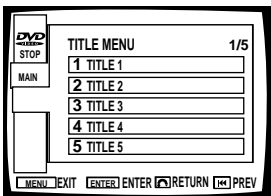

Titles can be selected and played back. This selection screen is the same as the one in "Direct search with title numbers" on page 45.

Menu screen contents

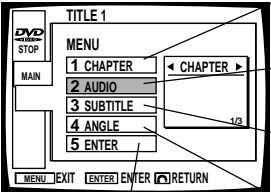

To go to the Chapter screen

In the Chapter screen:
One chapter (song) within a title can be selected and played back.

To go to the Audio screen

In the Audio screen:
Audio contents can be selected on discs that include more than one audio language or audio type.

To go to the Subtitle screen

In the Subtitle screen:
Subtitle contents can be selected on discs that include subtitle information.

To go to the Angle screen

In the Angle screen:
The scene angle that you want can be selected on discs that include scenes that have been filmed from various angles.

Completes the setting of changes to the above items.

Button operation within each menu

Button name	Button shape	Operation
MENU button		For displaying or closing menu screens (settings are invalidated)
RETURN button		To return one menu screen back (settings will be memorized) However, search is invalidated.
Number buttons		Selection and conclusion (In the set up menu, some items only operate for selection.)
Direction buttons		Selection
ENTER button		Setting and implementation (playback mode is engaged after title or chapter change)
PREVIOUS button		To go to the previous page
NEXT button		To go to the next page
Direct buttons		To go to menus (setting selected before moving to a new menu will be invalidated)

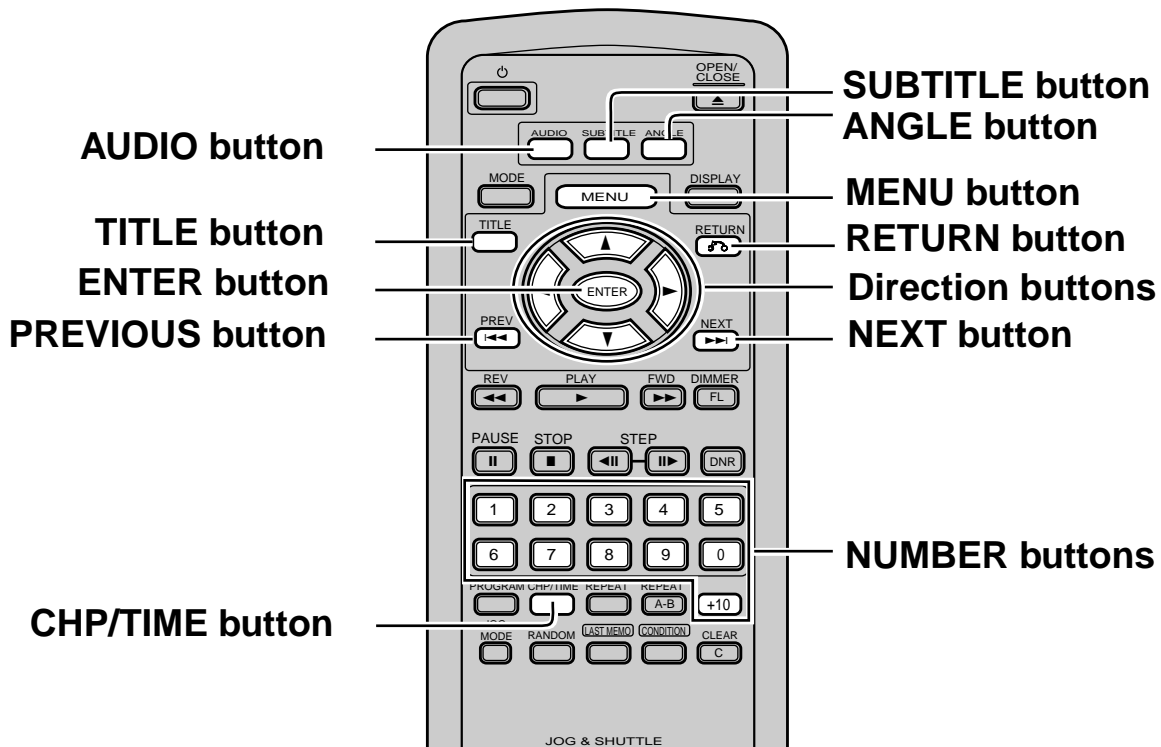

Preparation

Basic Operation

Setup

Detailed Operation

Other Information

About the main menu

Example of screen displays and operation

GUI (Graphical User Interface)

Ex. 1: Display contents and button functions within the Menu screen

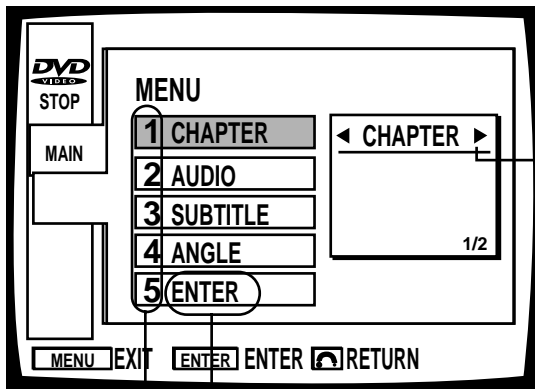

When the ◀ and ▶ marks are displayed, settings can be changed with the direction buttons ◀/▶.

Memorizes any changes that have been made to the above settings.

Item numbers

Selecting an item number by pressing the **number buttons** or using the direction buttons ▲/▼ and then pressing the **ENTER button** will display the menu screen for that item number. Selecting item "5 ENTER" however, will memorize the changed settings and quit the mode.

Ex. 2: Display contents and button functions within the Set-up menu screen

Current set-up condition

Item numbers are selected with the **direction buttons** ▲/▼, and settings are changed with the **direction buttons** ◀/▶.

Current set-up condition

When selection is made with the **number buttons** or the **direction buttons** ◀/▶, pressing the **ENTER button** will display the selection screen selected.

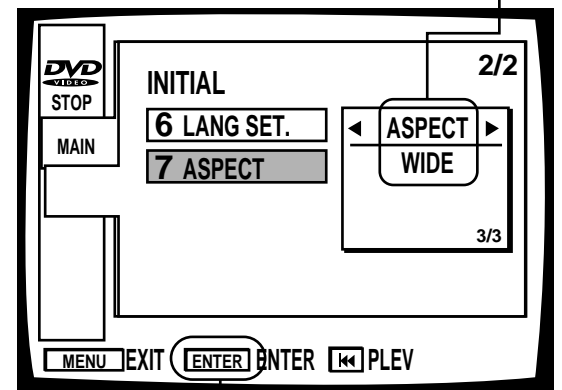
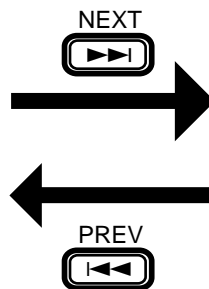
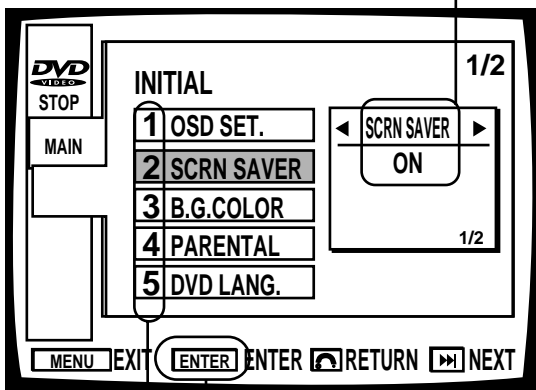

Selecting this will memorize changed settings and quit the mode.

Selection item numbers

Selecting an item number by pressing the **number buttons** or using the direction buttons ▲/▼ and then pressing the **ENTER button** will display the menu screen for that item number.

Changing Settings

Place the disc on the disc table and press the MENU button during stop mode.

- The main menu screen will be displayed.
- The menu screen for a CD or Video CD will differ from the one shown on the right.

Select settings in **SETUP** of the main menu screen on the right.

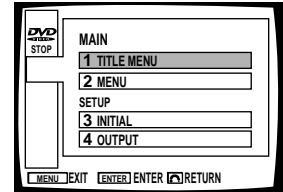

How to go to the various menus is shown in the following outline.

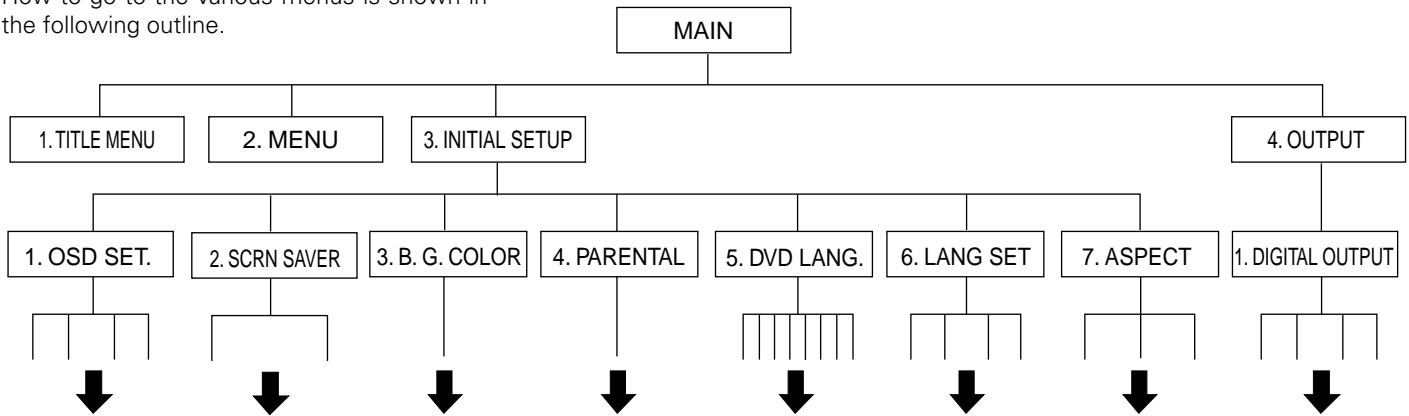

- After settings have been changed, to return all modes to their initial settings, set the power to the standby mode, and, while pressing and holding the main unit's STOP button, press the \odot STANDBY/ON switch. "Picture quality/Tone setup", "Condition Memory", "Last Memory" and the code number of "Parental level" settings will also be erased.

INITIAL SETUP

OSD SET., SCREEN SAVER, B.G. COLOR, PARENTAL, DVD LANG., LANG SET., and ASPECT setup is possible.

- In each setting explanation, the setup mode first explained is the initial factory setting. (* is marked.)

1. OSD SET.

- 1. DISPLAY:** Operation displays (play, stop etc.) can be displayed or not displayed by selecting ON or OFF.
Settings: ON* (Operation displays appear.)
OFF (Operation displays do not appear.)
- 2. POSITION:** When watching conventional software on a wide screen TV, the operation display is right at the top of the screen, and you may not be able to see it at all. Changing the position of the display lets you see operation indications clearly even on a wide TV screen.
Settings: NORMAL* (When using a conventional (4:3) TV)
WIDE (When using a wide screen TV (not for menu displays))
- 3. LANGUAGE:** This setting is used to display operation indicators and menu screens is the setup to switch the language you desire.
Settings: English*
Select the language you desire with the direction buttons and press the **ENTER** button.
- 4. ANGLE MARK:** When a picture that is recorded in different angles is played back, will be displayed.
This setting lets you see clearly whether the playback picture is recorded with angles or not.
Settings: ON* (is displayed.)
OFF (Not displayed.)

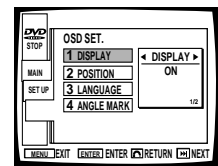

Changing Settings

2. SCRIN SAVER (Screen saver)

When a paused image is displayed for a long period of time, the image may be “burned” onto the screen. On this player, a screen saver function is included in order to prevent screen burn when an image such as a menu screen etc., is continuously displayed for a long time (more than 5 minutes). We recommend that you leave this mode ON.

Settings: OFF* (Screen saver is not functioning.)
ON (Screen saver is functioning.)

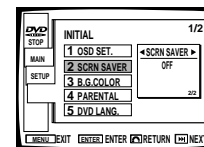

3. B.G. COLOR

Lets you select background color for menus and for screen color when no software is playing. You can set R (red), G (green), and B (blue) independently. Setting for each color is possible in 21 steps.

Settings: Blue*
Switchable

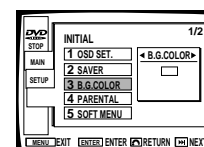

4. PARENTAL

This lets you control what your children watch by blocking out undesirable material.

This player lets you use Parental Lock if the disc has a parental code recorded on it. With Parental Lock capable discs, you can skip material you feel is inappropriate for your children. For details, refer to the instructions that come with the disc.

Once you have input a secret 4-digit number, the viewing level (user restriction level) cannot be changed unless the same four numbers are input.

Be sure not to forget your secret number. If you do forget it, return to the initial settings and input the secret number once more. (Page 31)

Setup method

- Press the **ENTER** button.
 - The code number input screen is displayed.
- Input the code number with the number buttons.
- Select a level between level 1 to 8 with the direction buttons.
- Press the **ENTER** button.
 - Viewing restrictions are applied to the disc.
- On discs where viewing restrictions have been set:
 - The screen shown on the right is displayed when the **PLAY** button is pressed to start playback.
 - Playback will start after the number buttons have been pressed to input the code number on this screen, and the **ENTER** button has been pressed.

1

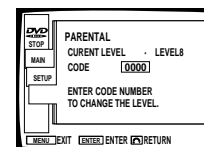

2

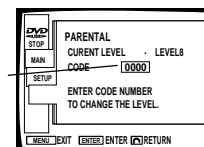

3~4

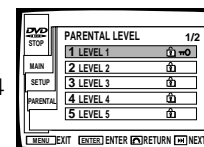

5

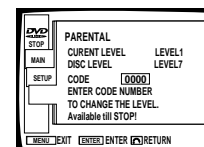

5. DVD LANG.

Some DVDs include the same menu screens recorded in various languages.

On these type of discs, the language in which you want to display menu screens can be selected on the **DVD LANG.** menu.

Setting : English*
: Select the language with the direction buttons and press the **ENTER** button.



6. LANG SET.

1. AUDIO: The audio language that you normally listen to can be selected from the various audio languages on a disc. Even when the audio language is changed during playback, the language selected at this setting will be selected when the disc is replaced.

Settings: English*

Select a language from the 136 different languages.

- Select the basic audio with the direction buttons ◀/▶ on the remote control unit.
- Press **ENTER** button to display the code input screen. Referring to the input codes (high order, low order) on the following language code list (Page 58), use the remote control's number buttons (For selection of numbers above 10, use the +10 button) to select the number that corresponds to the language that you want to select.

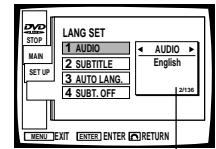

Basic audio

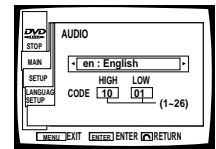

Code setup screen

2. SUBTITLE: The subtitle language that you will normally display can be selected from the subtitles on a disc. Even when the subtitle language is changed during playback, the language selected at this setting will be selected when the disc is replaced.

Settings: English*

Select a language from the 136 different languages.

- Press **ENTER** button to display the code input screen. Select the basic subtitle with the direction buttons ◀/▶ on the remote control unit.
- Referring to the input codes (high order, low order) on the following language code list (Page 58), use the remote control's number buttons (For selection of numbers above 10, use the +10 button) to select the number that corresponds to the language that you want to select.
- After selecting this display with the remote control's direction buttons ▲/▼, display ON and display OFF can be selected with the remote control's direction buttons ◀/▶.

Settings: ON*

OFF

- Some discs provide subtitles offering explanations of scenes for those who are hard of hearing. Switching "ASS. SUBTIT" ON assures these subtitles are displayed from the beginning.

Settings: OFF*

ON

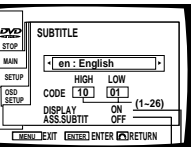
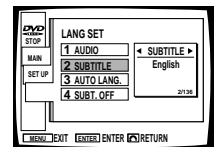

Assist subtitle

Display

3. AUTO LANG.:

Settings: ON* (For general overseas movies, original audio with your local subtitles will be selected, and for domestic movies, original audio with no subtitles will be selected.)

OFF (Basic audio, basic subtitle setting.)

If the selected audio language and the subtitle language are not the same, if the subtitle display is set to OFF, or if the ASS. SUBTIT is set to ON, the AUTO LANG function dose not operate.

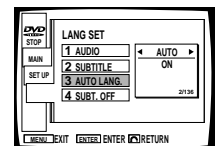

4. SUBT. OFF: The subtitle which is displayed by discs can be selected, when the subtitle is set to "OFF".

Settings: SEL SUBTL*(The selected subtitle language will be selected.)

WITH AUDIO (The selected audio language will be selected.)

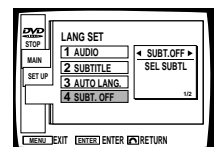

Changing Settings

7. ASPECT

When viewing software recorded in the wide mode, the image's height to width ratio can be switched to match the TV being used.

Settings: Wide*
Pan & Scan
Letter box

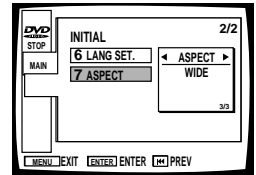

For DVDs where aspect switching is possible, select the aspect that matches the TV.

Disc	Aspect selection	Wide TV (16:9)	Regular TV (4:3)
16:9	Wide		
	Pan & Scan		
	Letter box		
4:3			

- Normally select WIDE for a wide TV.
- Normally select PAN&SCAN or LETTER BOX for a regular TV.

The above chart's shaded areas reflect recommended aspect settings.

- Whether the aspect can be switched or not depends on the disc. Please refer to the information written on the disc's jacket etc.
- For discs where aspect selection is not possible, make the screen adjustment using the TV's controls.

Tips

- The width-to-height ratio of conventional TVs is 4:3, while the width-to-height ratio of wide screen and Hi-Vision TVs is 16:9. This width-to-height ratio is called the aspect ratio.

OUTPUT SETUP

Digital output setup is possible.

Audio output from the optical digital output jack and coaxial output jack of this unit can be changed.

Digital output can be turned on or off with the ◀/▶ buttons.

Settings: ON* (Digital audio is output)

OFF (Digital audio is not output)

The initial setting (set at the factory before shipping) has been set to ON.

- In each setting explanation, the setup mode first explained is the initial setting (set when shipped from factory). (* is marked.)

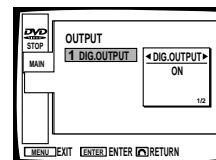

DIG. OUTPUT

Set output setup to the setting that suits the component connected.

- Set to Dolby Digital for an AV amplifier compatible with **DOLBY DIGITAL**.
- Set to 96KHz for an AV amplifier compatible with **96 KHz** linear PCM.
- Set to MPEG for an AV amplifier compatible with **MPEG**.
- Set to **ON** for an AV amplifier compatible with DTS.

Note

Do not change the output setting if you are not sure which system your amplifier is compatible with.

1. **DOLBY DIGITAL:** This player lets you change the audio output via an optical digital output jack and a coaxial digital output jack. Selection of a DVD's Dolby Digital audio (3-dimensional audio used in theaters etc.) or Linear PCM (same digital audio as that on CD) can be made.

Settings: **DOLBY DIGITAL*** (The Dolby Digital signal is output as is (when an amplifier with built-in Dolby Digital (AC-3) decoder is used).)

DOLBY DIGITAL→PCM (Provides Linear PCM sound with both Dolby Digital and Linear PCM sources (when a regular amp or Dolby Pro Logic amp is used).)

2. **LINEAR PCM:** **96KHz:** PCM audio discs with a 96KHz sampling frequency can be played back at the 96KHz high quality sound setting. **48KHz:** Discs with a 96KHz sampling frequency can be played back at a compressed 48KHz with this setting. 48KHz discs will be played back at 48KHz.

- When the audio sampling frequency recorded on the disc is set as desired, output will also be switched between analog/digital output at the same time.

- Some 96 KHz DVDs are copy protected. With this kind of disc, no signal is output from the digital output terminal.

Settings: **48KHz***
96KHz

3. **MPEG:** When a decoder or amplifier that has an MPEG input jack is used, the audio output from this unit's digital output jacks can be changed.

Selection of a DVD's MPEG or linear PCM signal can be made.

Settings: **MPEG→PCM*** (Output is in the linear PCM standard whether the signal is an MPEG signal or a linear PCM compatible signal.)

MPEG: (MPEG signal is output as is. (When using an amplifier with a built-in MPEG decoder.))

4. **DTS:** When using an amplifier that has a DTS input jack, the DTS signal can be set to be output (ON) or not output (OFF) for DVDs that have been recorded with DTS signals.

Settings: **OFF*** (not Output)
ON (output DTS signals)

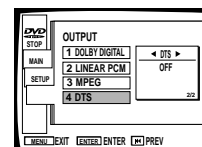
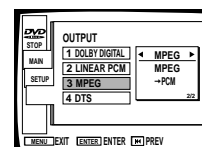
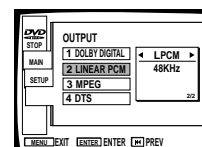
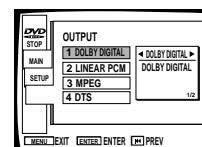

Changing Picture and Sound Quality

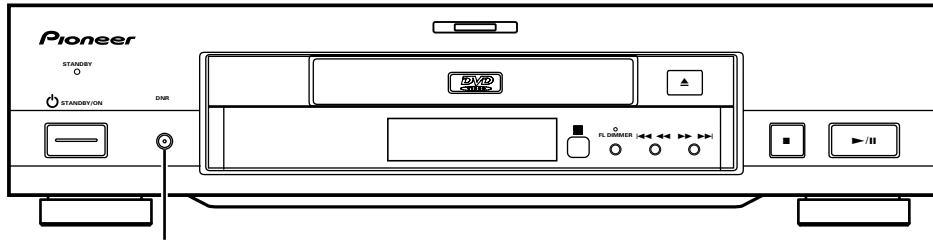

DNR indicator

The setting changes as follows according to how many times the MODE button is pressed.

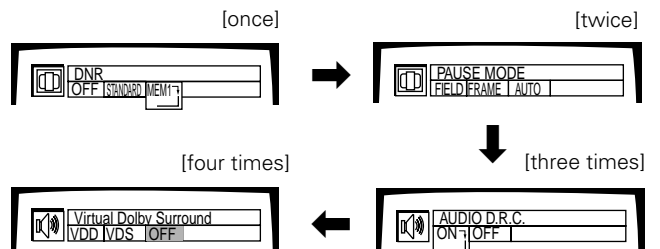

Mode selection will be as shown below depending on the disc being used.

Disc	Press once	twice	three times	four times
DVD	DNR	PAUSE MODE	AUDIO D.R.C.	Virtual Dolby Surround
Video CD	DNR	Virtual Dolby Surround	—	—
CD	Virtual Dolby Surround	—	—	—

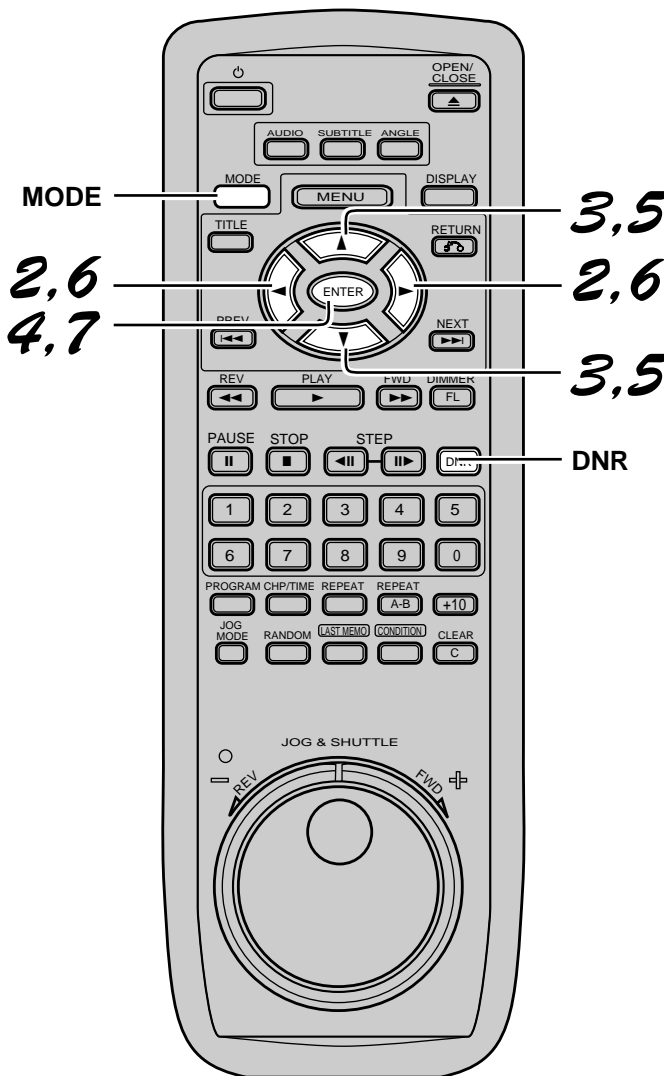

Changing picture quality of DVD's and Video CD's (DNR)

This lets you select the ideal picture quality for watching regular movies, animation, and other video media.

1 During playback, press **MODE** to select "DNR".

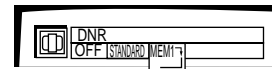

2 Press direction buttons **◀/▶** to select desired "DNR"

OFF
Picture quality: When the picture is unclear depending on the contents of the software and the TV used, switch to the Standard mode.

STANDARD
Returns you to normal picture, quality, and display.

MEMORY
Picture quality: Picture quality can be adjusted as desired and then recorded.

3 Select **MEMORY** where setting is to be memorized with **▲/▼**.



The desired picture quality can be memorized temporarily at TEMPORARY or permanently at MEMORY 1 or 2.

4 Press **ENTER** button.

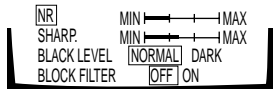

5 Press direction buttons **▲/▼** to select an item to be adjusted.

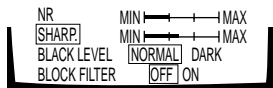

NR

Picture quality : Effective for luminance.

SHARPNESS

Picture quality : Adjusts picture's edge (outline)

BLACK LEVEL

Picture quality : Produces a modulated image with distinct blacks.

BLOCK FILTER

Picture quality : Effective for block noise characteristic to MPEG format.

6 Adjust with direction buttons **◀/▶**.

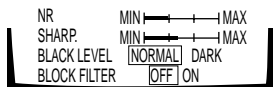

7 Press **ENTER** button.

Tips

- When left for 5 seconds, the display will change to the selected adjustment line only. This is convenient for making adjustment while viewing the picture. To display all items, press the RETURN button.

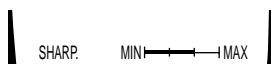

Changing the still picture condition of DVD's

Effect

FIELD: Picture quality: Picture shake will be eliminated during a paused picture.

FRAME: Normal mode.

AUTO: Selects field or frame automatically according to disc.

1 During playback, press **MODE** to select "PAUSE MODE".

2 Press direction buttons **◀/▶** to select desired pause mode.



- Picture quality selection can also be done with the DNR button. The display will change as follows each time the DNR button is selected.

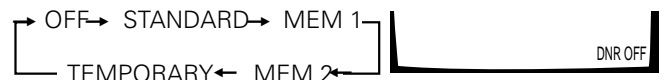

Changing Picture and Sound Quality

Changing the sound quality of DVD's (AUDIO D.R.C.)

AUDIO D.R.C. stands for Dynamic Range Compression. DVDs provide sound with wide dynamic range. Switch AUDIO D.R.C. ON if you find dialog or other sounds hard to hear when listening on your stereo system or TV.

- 1 During playback, press **MODE** to select "AUDIO D.R.C."
- 2 Press direction buttons **◀/▶** to select "ON"
- 3 Press **ENTER** button.

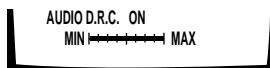

- 4 Adjust the amount of change with the direction buttons **◀/▶**.

- MIN: The dynamic range becomes narrower.
- MAX: The dynamic range becomes wider.

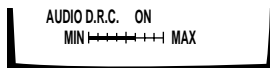

- 5 Press **ENTER** button.

- The setup screen is closed.



If **▲** button or **▼** button is pressed during step 4, change will be in the order of "ON" or "OFF".

Note

- ◆ When Virtual Dolby Surround is selected, if DOLBY DIGITAL in the digital output setting is set to "DOLBY DIGITAL → PCM", there may not be output from the digital outputs.
- ◆ When playing multi-channel material, set Virtual Dolby Surround to VDD (Virtual Dolby Digital) mode. The VDD effect is more dramatic than the VDS (Virtual Dolby Surround) mode.
- ◆ When Virtual Dolby Surround is turned ON for karaoke etc., on a Video CD, the vocal may not be loud enough, even when karaoke audio is selected. In this case, please set the Virtual Dolby Surround mode OFF.

Selecting a theater-like 3-dimensional sound image (Virtual Dolby Surround)

Effect

Virtual Dolby Surround: 3 dimensional sound field will be created even when only 2 front speakers are being used.

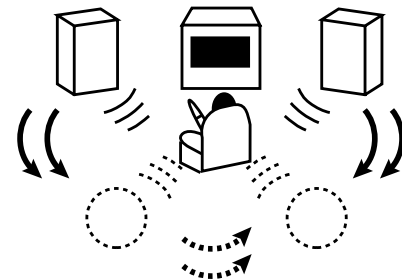

- 1 During playback, press **MODE** to select "Virtual Dolby Surround".

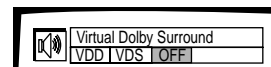

- 2 Press direction buttons **◀/▶** to select "VDD" or "VDS".

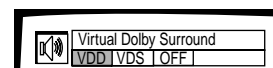

VDD: Virtual Dolby Digital

(3 dimensional sound field processing from the multi-channel audio signal takes place. A larger effect is obtained compared to Virtual Dolby Surround. Please normally set to the Virtual Dolby Digital mode.)

VDS: Virtual Dolby Surround

(3 dimensional sound field processing from the 2 channel audio signal takes place.)

OFF: off



- This feature only operates for audio output from the AUDIO OUT jack. It will not operate for audio output from the DIGITAL OUT jacks.
- There may be little or no effect with some types of discs.



Memorizing Settings for Often Viewed DVDs (Condition Memory)

You can store memory settings for DVDs you often watch. Settings remain in memory even if you remove the disc from the player, or switch power to the player OFF. If you load a disc that has its settings memorized, the **CONDITION** indicator lights. When you start playing the disc, the memorized settings are automatically recalled.

You can memorize details for the following seven settings. Once memorized, Condition Memory will automatically recall the settings.

- Position (Page 31)
- Parental level (Page 32)
- Multi-Aspect (Page 34)
- DNR (Page 36)
- Multi-language (Page 40)
- Multi-language subtitles (Page 41)
- Multi-Angle (Page 41)

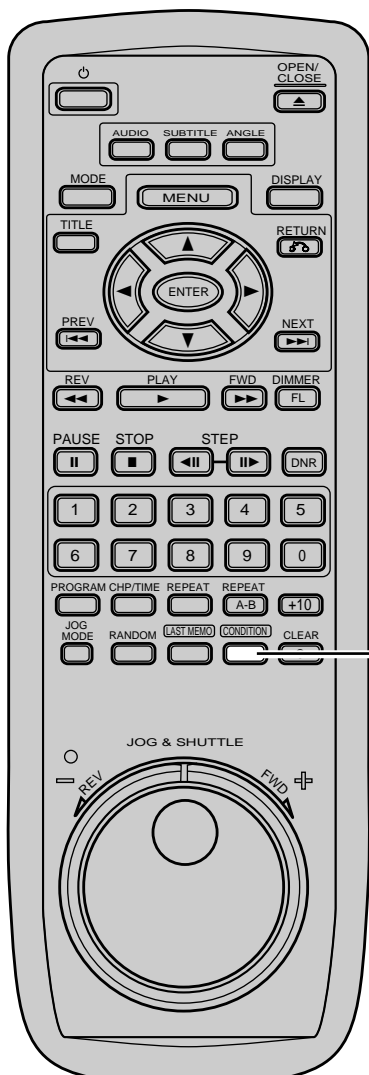

CONDITION

1 Press **CONDITION button during playback.**

When a disc that has memorized settings is loaded...

"**COND.MEM.**" will appear on the screen, and the previously memorized settings will be selected.

Erasing the recorded contents

Load the disc that has memorized settings, and press the **CLEAR** button while "**COND.MEM.**" is being displayed. The disc's recorded data will be erased.



- Settings are stored in memory for use any time.
- You can store settings for up to 30 DVDs in memory. If you memorize settings for more than 30 DVDs, previously memorized settings are erased in order from the least recently memorized settings. Subsequently, if you try to call up these previously memorized settings, you will get the latest settings that have taken their place.
- To make changes to Aspect ratio, DNR, Subtitle language, Audio, Angle and Parental settings, press **CONDITION** button during playback.
- Switching of the multi-audio mode etc., is automatic on some discs.



Selecting Languages (Multi-Language)

Dolby Digital, PCM, and other audio data can be recorded on DVDs in a number of languages, letting you choose the desired language.

1 Press **AUDIO** button during playback.

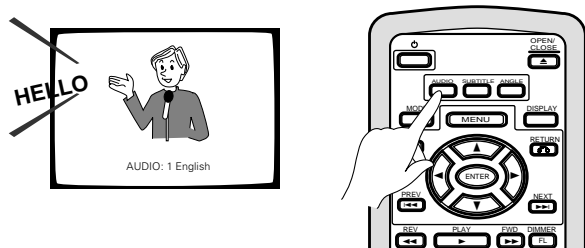

Tips

- For some titles, selection can be made using the menu. In this case press the **MENU** button while the indicator is displayed to display the menu screen and then make your selection.

Note

- ◆ You cannot switch languages if there is only one language recorded on the disc.
- ◆ Switching the audio language may not be possible with some titles. In this case, the  mark will be displayed.

2 Press **AUDIO** button to select the desired language.

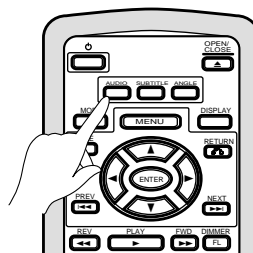
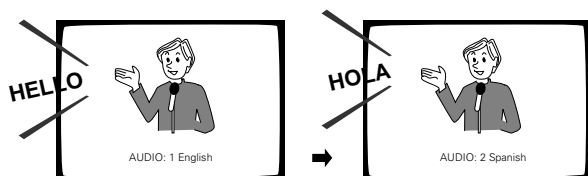

Changing Audio Type

1 Press **AUDIO** button during playback.

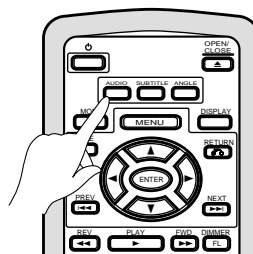
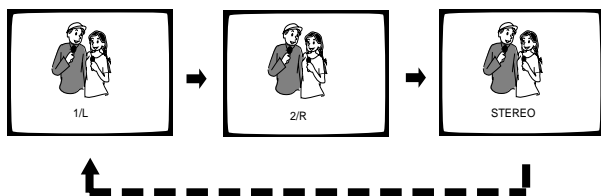

- Audio type changes each time you press the button.

Tips

- With karaoke and other discs, set the appropriate audio type for singing and accompaniment after referring to information on the disc jacket or accompanying material.



Selecting a Subtitle Language (Multi-Language Subtitles)

You can select a desired subtitle language with DVDs that have subtitle data in multiple languages recorded on them.

1 Press SUBTITLE button during playback.

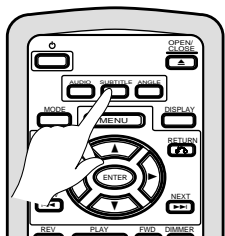

- You can also make your selection from a menu.

Note

- ◆ The subtitle language can not be switched if the subtitle language is not recorded, or if only one language is recorded.
- ◆ Switching the subtitle language may not be possible with some discs. In this case, the mark will be displayed.

Tips

- To clear subtitles during playback, press **CLEAR** button after first pressing **SUBTITLE** button. You can also clear subtitles by selecting OFF in the subtitle menu display.
- Subtitles can be cleared by selecting LANG SET from the INITIAL menu, and setting SUBTITLE to "OFF" (refer to page 33).
- For some discs, selection can be made using the menu. In this case press the **MENU** button while the indicator is displayed, display the menu screen and make your selection.

2 Press SUBTITLE button to select the desired language.

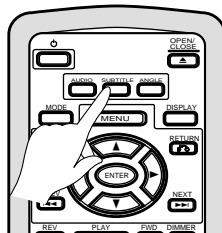

Viewing from a Desired Camera Angle (Multi-Angle)

With DVDs featuring recordings of images shot from different angles, you can choose a desired viewing angle.

1 Press ANGLE button during playback.

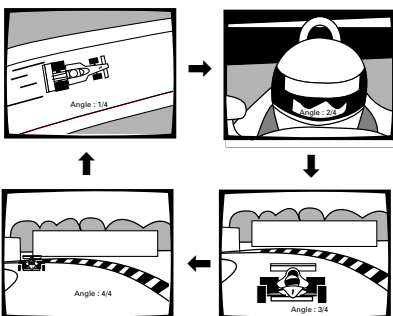

- The camera angle changes each time you press the button.

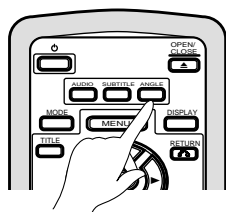

To check whether or not the disc is recorded with angles:

The jacket of discs that are recorded with angles will be marked with . Also, on this unit, when locations on discs that are recorded with angles are played back, the mark can be displayed.

To cancel the angle mark, please see page 31.

Tips

- You can use the Multi-Angle function only with discs featuring recordings of images shot from different camera angles.
- During Multi-Angle playback, the Angle indicator on the player lights.
- For some discs, selection can be made using the menu. In this case press the **MENU** button while the indicator is displayed to display the menu screen and then make your selection.

Viewing Disc Information

Press **DISPLAY** button during playback.

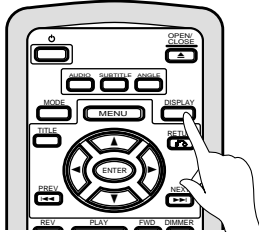

- The display will change as follows each time the button is pressed. Some displays may not be displayed depending on the title.

Press **DISPLAY** button in the **STOP** mode.

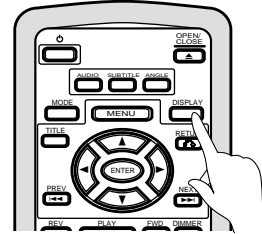

- Disc information is displayed.

Note

◆ Information may not be displayed for some discs.

DVD

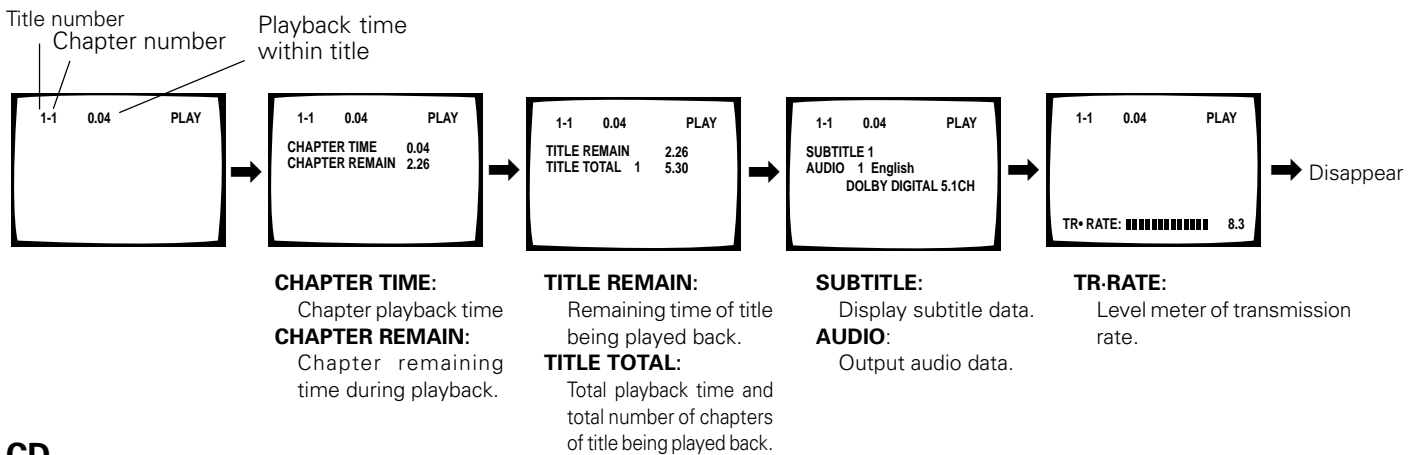

CD

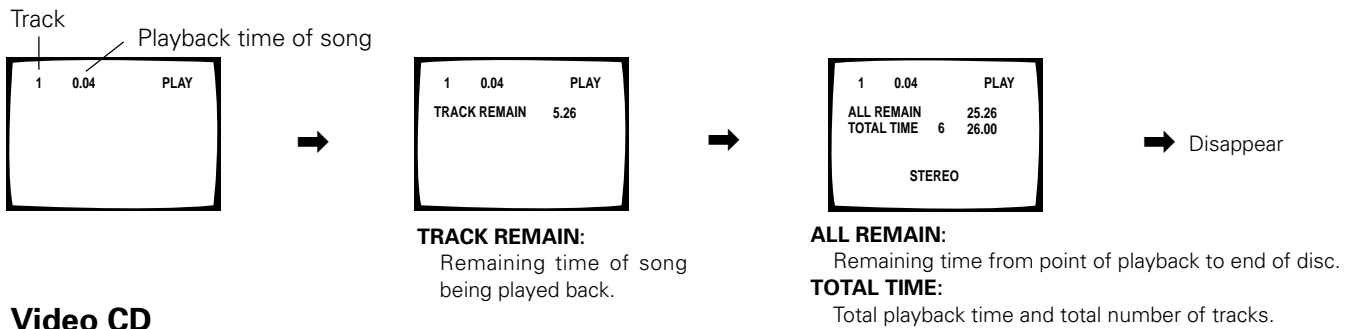

Video CD

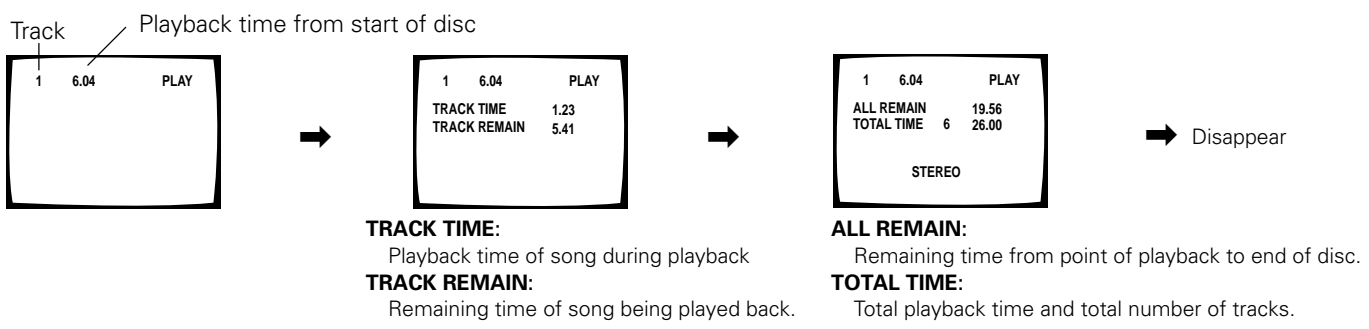

Detailed Operation

Continuing Playback from Where You Stopped	44
Searching For A Desired Video Scene (Title Search)	45
Searching for a Desired Video Scene/Audio Track (Chapter/Track Search)	46
Playback in a Desired Order (Program Play)	47
Repeat Play	50
Still Frame/Slow Play/Frame Advance	51
Random Play	52

Other Information

For Proper and Long Use	53
Troubleshooting	54
Terms	56
Language Code List.....	58
Specifications	60

Continuing Playback from Where You Stopped

This function is convenient for when you want to continue viewing a disc from the point that was last viewed up to.

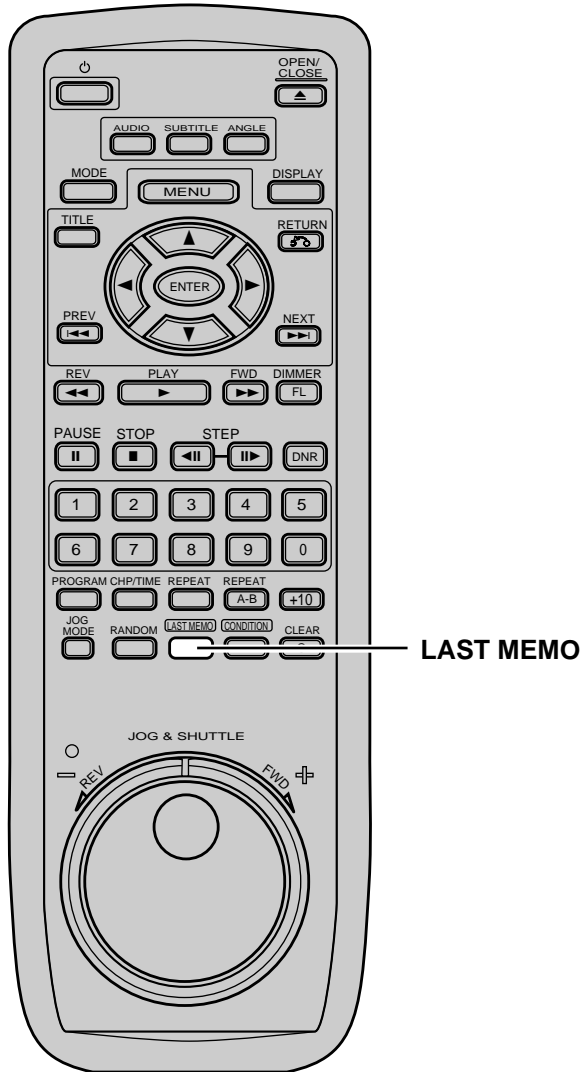

Memorizing the place where you stopped watching

1 Press the **LAST MEMO** button during play.

- The LAST MEMORY indicator lights on the player.

2 Press **STANDBY/ON** switch to turn the power off, or stop playback with **STOP** button.

Once memorized, the memorized point will be remembered even if the power is turned off, or the disc ejected. Points on up to 5 discs can be memorized, and those points recalled the next time any of the discs are played back.

Resuming playback from where you stopped

1 Load the disc that has been memorized with the point where viewing is to continue from.

- Some DVD discs will start playback automatically when loaded. In this case, press the stop button once to stop playback.

2 Press the **LAST MEMO** button during **STOP**.

- When the power is turned off and a disc inserted, the power will be turned on and playback will start automatically.

memo

- ◆ In the case of DVDs, the Last Memory mode may not function for some discs.
- ◆ If you register more than five DVDs, details of the latest disc are memorized, while details of the least recent disc (the disc you registered first) is erased.
- ◆ Even with a disc you have memorized with LAST MEMORY, playback begins at the start of the disc if you press the **PLAY** button.
- ◆ When you continue playback from the point where you stopped, LAST MEMORY is automatically canceled for that disc.

- ◆ This function is for playback of DVDs only. You cannot use it with CDs, and other discs.
- ◆ When a Video CD is ejected, memorized data will be cleared.
- ◆ When PBC playback is engaged on Video CDs, continuous playback may not be possible. If continuing playback is not possible, playback the disc without displaying the menu. (refer to page 25)
- ◆ If playback was started automatically, press the LAST MEMO button after first pressing the **STOP** button once.



Title 1

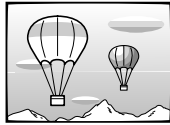

Title 2

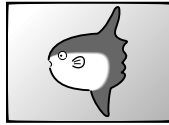

Searching for a Desired Video Scene (Title Search)

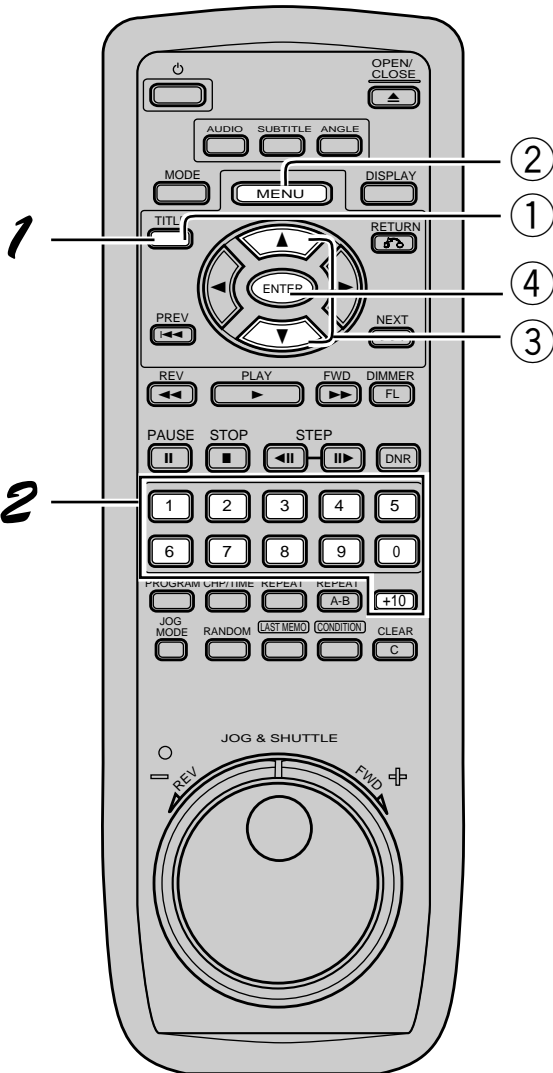

Direct search with title numbers

1 Press **TITLE** button.
(During the stop mode, proceed to step 2 without pressing the **TITLE** button.)

2 Press the number buttons.

• To select title number 3, press the 3 button

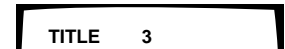

• When selecting title number 10, press +10 button → 0 button

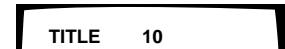

• Pressing and holding the **TITLE** button while the **TITLE** number is flashing will advance the **TITLE** number one by one. Selection can be made by selecting the desired number and pressing the **PLAY** button.

Searching with the menu

1 Press **TITLE** button

• If the unit is in the stop mode, proceed to step 3.

2 Press **MENU** button.

3 Select a title number using the direction buttons **▲/▼**.

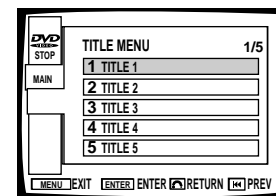

4 Press **ENTER** button.

• Playback of the selected title begins.

memo

- Direct selection is also possible using the number buttons. The selected title will begin playback immediately.
- For some discs, selection can be made using the menu. In this case, press the **MENU** button while the indicator is displayed to display the menu screen and then make your selection.

Note

- ◆ You cannot play back successive titles.
- ◆ To play back multiple successive titles, program the titles and then perform Program playback. (Page 48)
- ◆ With certain DVDs, the search operation may stop. In this case, the mark is displayed.
- ◆ Menus may not be displayed on some discs.

Preparation

Basic Operation

Setup

Detailed Operation

Other Information

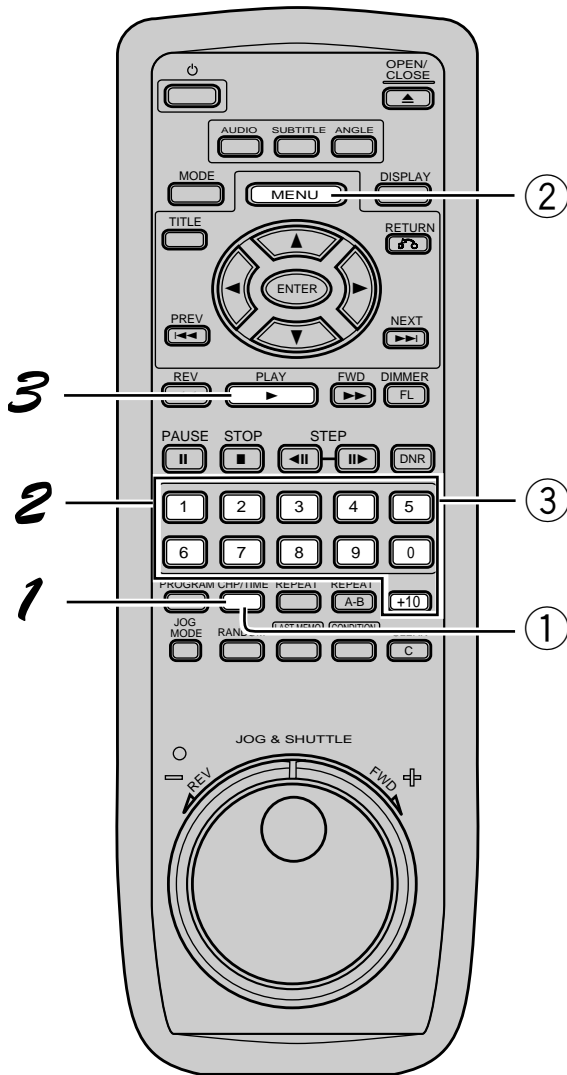
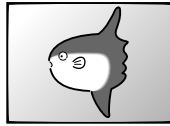
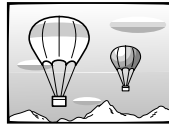

Search can be engaged two ways: By pressing the direct number buttons, or by pressing the chapter/track button and then pressing the number buttons.

Direct search using number buttons.

Direct search using number buttons.

Example 1: When selecting chapter/track number 3, press the 3 button.

Example 2: When selecting chapter/track number 17, press +10 button → 7 button.

During the stop mode on a DVD, use the "Searching for a Desired Video Scene (Title Search)" (Page 45)

When the chapter/track number is large

1 Press CHP/TIME button.

- Chapter/track numbers flash on screen.
- On DVDs, the menu may be displayed during the stop mode. In this case, please refer to "Chapter Number Search with the menu" on the right.

2 Select chapter numbers directly with the number buttons.

Example 1: When selecting chapter/track number 31, press 3 → 1 button.

Example 2: When selecting chapter/track number 187, press 1 → 8 → 7 button.

3 Press PLAY button.

- Playback of the selected chapter/track starts.



- To clear Title, Chapter, and Time indications when they are flashing, press the **CLEAR** button twice.
- For some discs, selection can be made using the menu. In this case, press the **MENU** button while the indicator is displayed, display the menu screen and make your selection.

On DVDs....

Chapter Number Search with the menu

① Press CHP/TIME button.

- If the stop mode is engaged, proceed to step 3.

② Press MENU button.

- Chapter menu is displayed.

③ Select the chapter by number.

- Depending on the title, the menu may not be displayed. In this case, please refer to the method on the left.

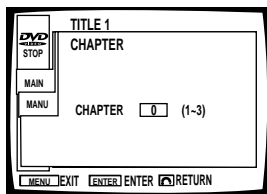

Note

- ◆ Time search is not possible with CDs.
- ◆ With DVDs, Time search may not be possible with certain discs. In this case, the  mark is displayed.
- ◆ When performing DVD Time Search, playback may start from a slightly different time than that specified.
- ◆ On DVDs, Time search is not possible during the stop mode.
- ◆ Search using the above operation is not possible during PBS playback of Video CDs.

Searching by time (Time search)

1 Press CHP/TIME button twice.

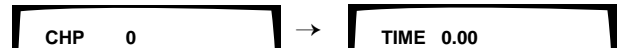

- With DVDs that do not have chapters, pressing the button once will display the time.

2 Select the desired time with the number buttons.

Example 1: To select 21 minutes 43 seconds
2 → 1 → 4 → 3

- You cannot search for chapters that overlap titles. You can only search for chapters within the same title.

3 Press PLAY button.

- Playback starts from the selected elapsed play time.

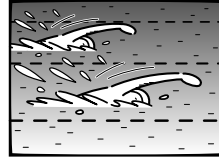
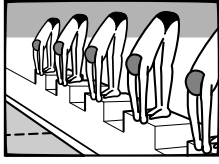

Playback in a Desired Order (Program Play)

On DVDs....

Programming (DVD)

Programs with a maximum of 24 steps can be memorized.

1 Press PROGRAM button.

2 Select the program type with the number buttons and press ENTER button.

- Follow procedure 4 to select a title.

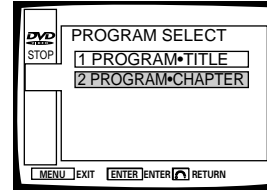

3 When chapter programming is selected, first press the direction button ▲ to move to TITLE, then use the number buttons to select the title that contains the chapter to be programmed.

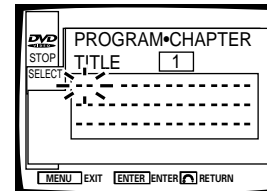

4 Programming DVD titles/chapters 9, 7, and 18 in order.

- Press 9, 7, +10 and 8.

DVD title

DVD chapter

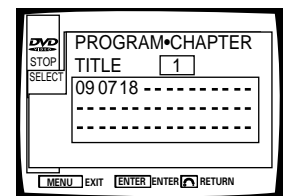
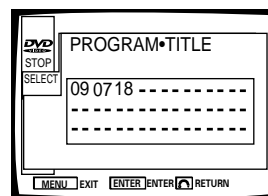

5 Press ENTER button.

- Playback starts in the set order.
- To stop the program play, press the STOP ■ button.

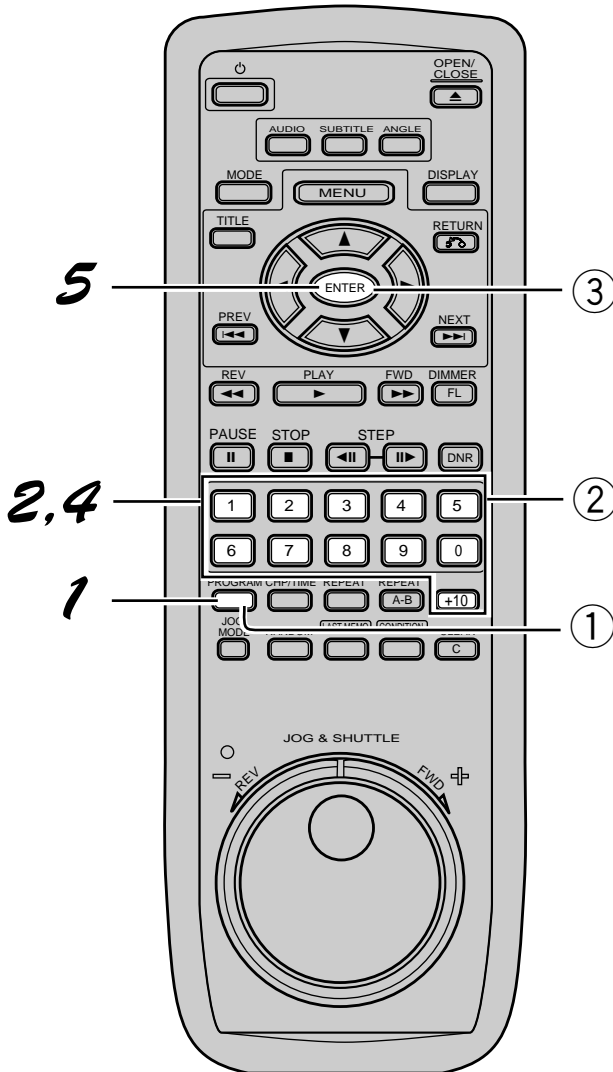

Note

- ◆ You cannot program when playing a Video CD using menu selections (during PBC).
- ◆ When moving chapters, chapters not programmed may appear on the screen, but this is not a malfunction.
- ◆ Programming may not be possible with certain DVD discs. On these types of discs, the mark will appear on the screen when programming is attempted.
- ◆ Only chapters within the same title can be programmed during chapter programming.

On CDs, Video CDs....

Program setting (Video CDs, CDs)

Programs with a maximum of 24 steps can be memorized.

① Press PROGRAM button.

② Programming tracks 9, 7, and 18 in order.

- Press 9, 7, +10 and 8.

③ Press ENTER button.

- Playback starts in the specified track order.
- To stop the program play, press the **STOP ■** button.

Programming a pause

Press the PAUSE button instead of a number button.

- **||** appears on the screen and the pause can be programmed.

When the wrong number button was pressed

Press the CLEAR button, and press the correct number button.

How to confirm, add to, or delete programs

To confirm

Press the PROGRAM button.

- Programs can now be confirmed on a CD or Video CD disc.

On a DVD, select the program type with the direction buttons ▲/▼ and press the ENTER button.

- Select either a 1 title program, or 2 chapter program.
- Programs can now be confirmed on a DVD.

Adding to a program

- 1** Press the PROGRAM button.
- 2** Press a number button, then press the PROGRAM button.

Deleting a program

- 1** Press the PROGRAM button.
- 2** Select the program with the direction buttons ◀/▶, then press the CLEAR button.

- The complete program will be deleted even if the disc table is open.
- Pressing the **CLEAR ■** button during the stop mode will clear all programs.

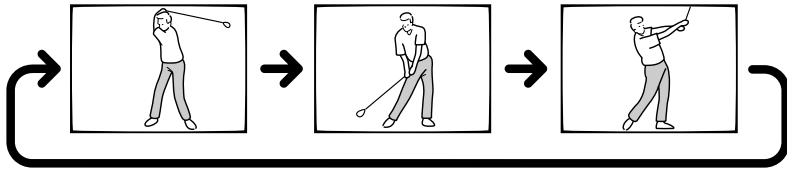

Repeat Play

Repeat play of a chapter/track

Press **REPEAT** button once during playback of the chapter or track you want to repeat.

Repeat play of a title

Press **REPEAT** button twice during playback of the chapter or track you want to repeat.

- With DVDs, the title continues playing until the end, and then playback starts once more from the beginning of that title.
- With CDs and Video CDs, a disc is title, so the entire disc is repeated.

Repeat play of a specified section

Press **REPEAT A-B** button at the beginning and end of the section you want to repeat.

Return to a specified location

- 1 Press **REPEAT A-B** button at the desired location.
- 2 When you want to return, press **PLAY** button.

- Press **CLEAR** button to clear a specified location.

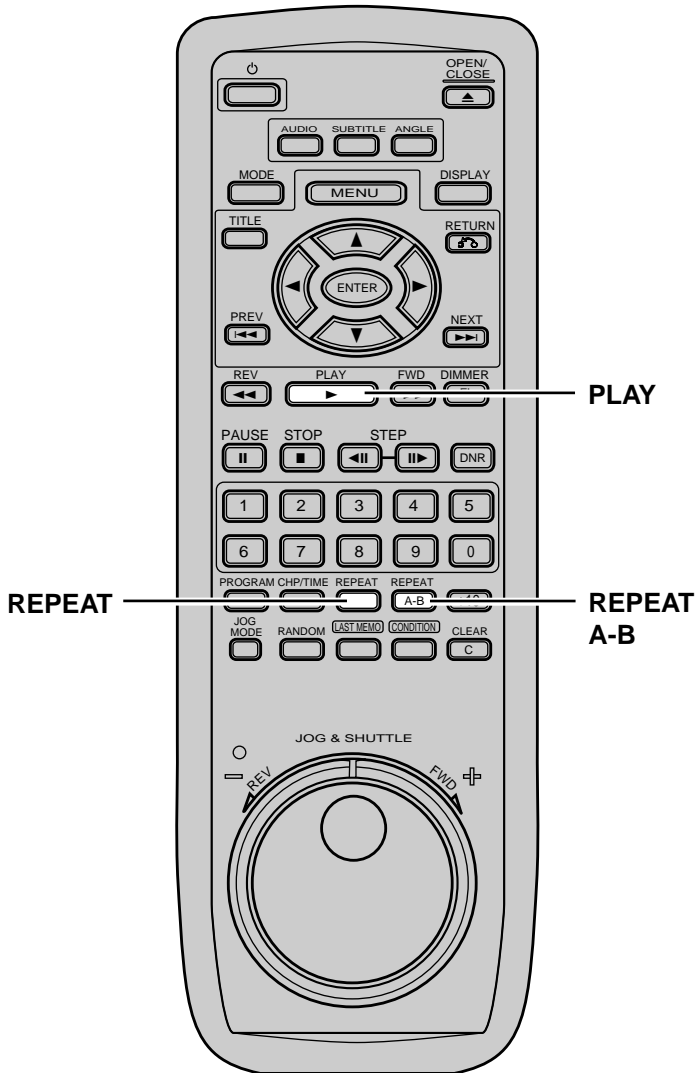

Note

- ◆ With some DVD discs, there may be times when Repeat playback is not possible because of the title. In this case, the mark will appear on the screen.
- ◆ With Video CDs, Repeat play is not possible during playback with the menu displayed (PBC playback). To perform Repeat play, start playback without displaying a menu (refer to page 25), and press REPEAT button.



- Press the **REPEAT** button during program playback to repeat playback of the program.
- Press **CLEAR** button to cancel Repeat play. The Repeat play mode is canceled, but playback continues.
- With DVDs, repeat playback between titles is not possible.

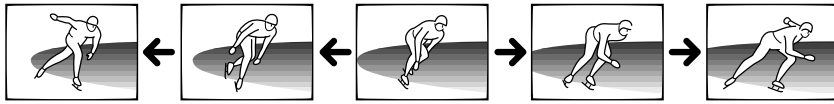

Still Frame/Slow Play/Frame Advance

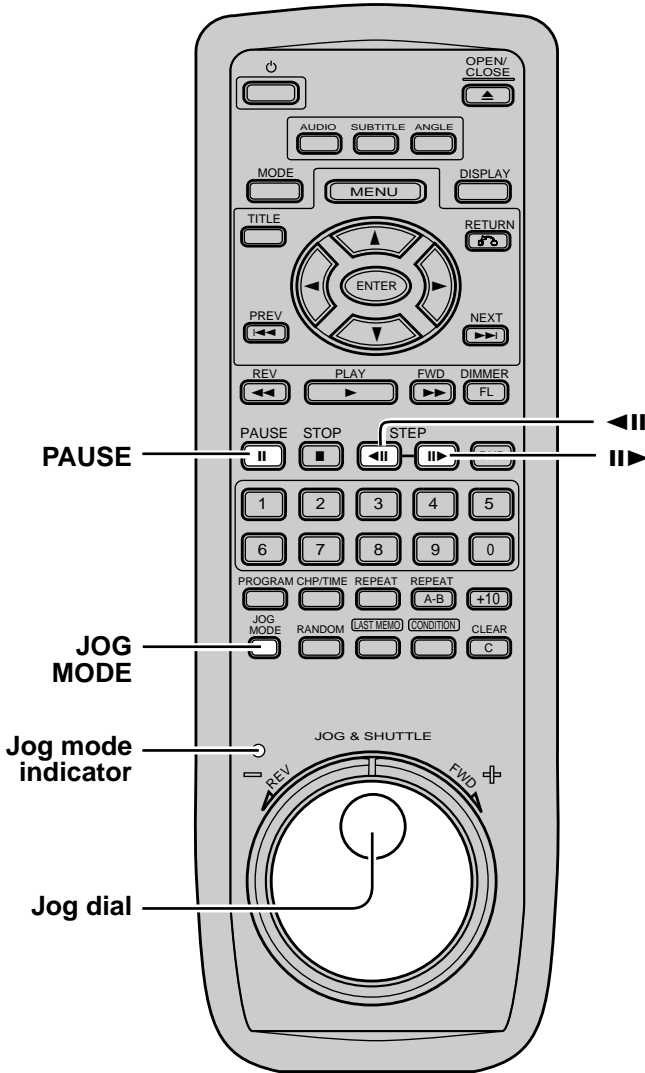

Note

- ◆ There is no sound when viewing still frames or slow playback, or when advancing one frame at a time.
- ◆ Pause, slow playback, or frame advance playback may not be possible with certain titles. In this case, the mark is displayed.



- To return to normal playback, press **PLAY** button (or the button on the player).

Viewing a still frame

Press PAUSE button.

- Press the button on the front of the player.
- If the still picture shakes on a DVD, refer to page 37 and select the "FIELD" setting.

Slow playback: Viewing a slow picture

Press and hold the or button during playback.

: Slow playback will be engaged.

During slow playback, the slow playback speed can be selected with the and buttons.

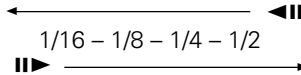

Press and hold the or button during DVD playback.

: Slow playback in the reverse direction will be engaged.

Frame by frame advance playback: Viewing the picture one frame at a time.

There are two operations for this function.

(Operation 1)

1 Press PAUSE button.

2 Press the or button.

: The picture will be advanced by one frame each time the button is pressed

: The picture will be backed up little by little each time the button is pressed. (DVD only)

(Operation 2)

Speed will change gradually from frame by frame speed to normal speed.

1 Press JOG MODE button.

- The remote control's jog mode indicator will light.

2 Slowly turn the JOG dial.

FWD : 1 frame is advanced each time the JOG dial is turned.

REV : Picture is reversed slightly each time the JOG dial is turned. This mode will not function for Video CDs.

- The still picture mode is engaged when you stop turning the JOG dial.
- Slow playback is possible according to the speed that the JOG dial is turned. (Only possible while the JOG dial is being turned).

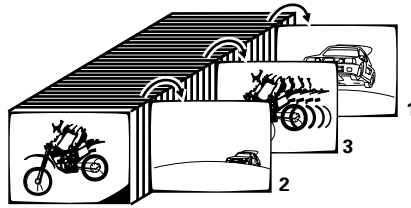

Random Play

On DVDs....

Random playback of chapters within one title

Press **RANDOM** button once, then press **ENTER** button.

- "RANDOM CHP" will appear on the screen, and chapters within the title will be played back in a random order.

Random playback of titles

Press **RANDOM** button twice, then press **ENTER** button.

- "RANDOM TITLE" will appear on the screen, and titles will be played back in a random order.

On CDs, Video CDs....

Press **RANDOM** button.

- "RANDOM" will appear on the screen, and random playback will begin.

During Random play:

- Press **▶▶** button, and the player's next song or scene starts playing.
- Press **◀◀** button, and playback of the current song or scene starts again from the beginning.

Stopping Random play

Press **CLEAR** button.

- This returns you to normal playback of chapters/tracks in order from the chapter/track currently playing.

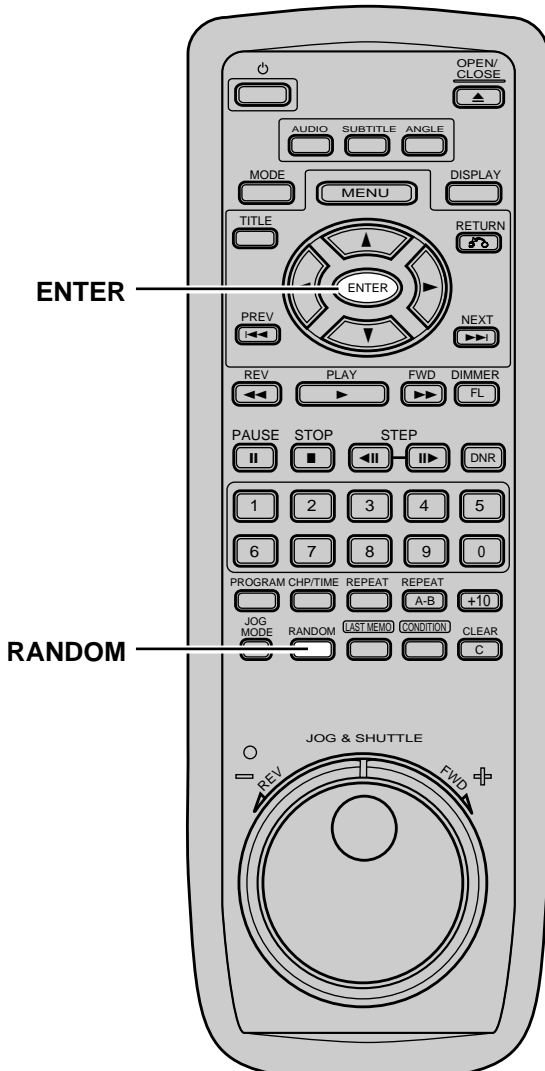

Note

- ◆ With Video CDs, Random play is not possible during playback with the menu displayed (PBC playback). To perform Random play, start playback without displaying a menu (refer to page 25), and press **RANDOM** button.
- ◆ Random play of programmed chapters/tracks is not possible.
- ◆ In the case of DVDs, random playback may not be possible with some discs.
- ◆ Repeat playback of random playback is not possible.

For Proper and Long Use

■ DO NOT MOVE THE UNIT DURING PLAYBACK

During playback, the disc rotates at high speed. Do NOT lift or move the unit during playback. Doing so may damage the disc.

■ WHEN MOVING THIS UNIT

When changing places of installation or packing the unit for moving, be sure to remove the disc and return the disc table to its original position in the player. Then, press the ϕ STANDBY/ON and switch the power standby. **Check that the “-OFF-” indication on the display goes off**, then disconnect the power cord.

Moving this unit with the disc loaded may result in damage to this unit.

■ INSTALLATION

- Select a stable place to the side of a TV set or stereo system to be connected to the unit.
- When using the unit with a stereo system, install the speakers a little bit away from the TV.
- Do NOT install the unit on top of a TV or color monitor. Install the unit away from equipment that may be affected by magnetism, such as a cassette deck.

■ AVOID INSTALLING IN A PLACE THAT IS:

- Exposed to direct sunlight
- Exposed to humidity or where ventilation is poor
- Extremely hot or cold
- Exposed to vibration
- Exposed to dust
- Exposed to oily smoke, steam or heat (for example, a kitchen)

■ DO NOT PLACE AN OBJECT ON TOP

Do NOT place an object on the unit.

■ DO NOT BLOCK VENTS

Do NOT use the player on top of a long-fibered carpet, bed or sofa, and do not cover it with a cloth etc. This will prevent heat radiation and could result in damage.

■ AVOID HEAT

Do NOT place the unit on equipment generating heat, such as an amplifier.

When installing the unit in a rack, place it on the lowest shelf possible (however, not where it is exposed to dust) and separated from the amplifier to avoid the heat generated by the amplifier or other audio equipment.

■ CAUTION: WHEN PLACING THE UNIT IN A STEREO RACK WITH GLASS DOORS

Be sure there is ample space between the unit and the glass doors when opening the disc table using the remote control. If the disc table opens against strong resistance, **such as a closed glass door**, damage to the unit may result.

■ CONDENSATION

Moisture will form in the operating section of the player if the player is brought from cool surroundings into a warm room or if the temperature of the room rises suddenly. When this happens, player's performance will be impaired.

To prevent this, let the player stand in its new surroundings for about an hour before switching it on, or make sure that the room temperature rises gradually.

Condensation may also form during the summer if the player is exposed to the breeze from an air conditioner. In such cases, change the location of the player.



■ SWITCH POWER OFF WHEN NOT USING THE UNIT

Depending on the strength of the TV or radio broadcast signal, having the TV or radio ON while power to the unit is ON may result in stripes on the TV screen or noise. However, this is not a malfunction of this unit or the TV or radio. In such a case, switch the power of the unit OFF.

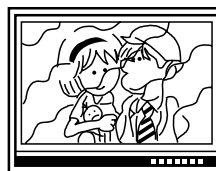



POWER-CORD CAUTION

Handle the power cord by the plug. Do not pull out the plug by tugging the cord and never touch the power cord when your hands are wet as this could cause a short circuit or electric shock. Do not place the unit, a piece of furniture, etc., on the power cord, or pinch the cord. Never make a knot in the cord or tie it with other cords. The power cords should be routed in such a way that they are not likely to be stepped on. A damaged power cord can cause a fire or give you an electrical shock. Check the power cord once in a while. When you find it damaged, ask your nearest PIONEER authorized service center or your dealer for a replacement.

Troubleshooting

Incorrect operations are often mistaken for trouble and malfunctions. If you think that there is something wrong with this component, check the points below. Sometimes the trouble may lie in another component. Inspect the other components and electrical appliances being used. If the trouble cannot be rectified even after exercising the checks listed below, ask your nearest PIONEER authorized service center or your dealer to carry out repair work.

	Symptom	Possible causes	Reference page
Operation	1. The disc comes back out even when the disc table is closed. 2. Playback is not possible.	<ul style="list-style-type: none"> ● The disc is dirty or warped. ● The disc is not placed properly on the disc table. ● Region No. does not conform with this unit. ● Condensation has formed inside the player. ● This player cannot play PAL and SECAM format DVD discs. ● The disc has been loaded upside down. 	p.55 p.24 p.57 p.53
Picture	3.  mark appears on screen. 4.  mark appears on screen. 5. Picture playback stops and the operation button can not be used. 6. Settings are canceled. 7. No picture. 8. Picture is dark. 9. The screen is stretched or aspect does not change. 10. Picture disturbance during playback. 11. When recorded on a VCR there is disturbance in the playback picture.	<ul style="list-style-type: none"> ● The selected function does not operate for that disc. ● The operation is prohibited by player. ● First stop the disc (press the ■ button), then start playback again. ● When the power is turned off by power failure or unplugging of the power cord, settings will be canceled. When unplugging the power cord, please be sure to do so after first canceling the display window's "-off-" indicator by pressing the Ⓞ STANDBY/ON button on the main unit or the remote control unit. ● Connection is incorrect. ● Operation (settings) of TV or AV amplifier is not appropriate. ● This unit is compatible with analog copy protect formatted copy guard. Some discs include a copy prohibit signal and when these types of discs are played back, the screen may darken depending on the TV. This not a malfunction of this unit. ● The multi aspect setting is not appropriate. ● This player is compatible with Macro-Vision System copy guard. Some discs include a copy prevention signal, and when this type of disc is played back, stripes etc., may appear on some sections of the picture depending on the TV. (This is not a malfunction.) ● This player is compatible with analog copy protect technology copy guard. Some discs include a copy prevention signal and the copy guard system will prevent proper playback. 	p.34
Remote control	12. Remote control operation is not possible. 13. Improper operation of TV set, etc., occurs.	<ul style="list-style-type: none"> ● The rear panel CONTROL IN jack on the player is being used. ● The remote control is too far from the player, or the angle with the remote sensor is too sharp. ● The batteries are exhausted. ● Some TVs that have wireless remote control functions may not operate properly with this remote control. 	p.15-16
Audio	14. Audio is not output or is distorted. 15. Noticeable difference in DVD and CD volume. 16. No digital output	<ul style="list-style-type: none"> ● The DIGITAL OUTPUT's Linear PCM setting is set to 96KHz. Digital output is prohibited on some discs. ● The disc is dirty. ● The connection plugs are not inserted fully into the terminals or are not connected. ● The connection plug or terminal is dirty. ● Audio cable connection is wrong. ● Connection is made to the stereo amplifier's PHONO input terminal. ● The pause mode is engaged. ● Stereo amplifier operation is wrong. (Check input (CD, AUX etc.) selector) ● The DVD playing is recorded in DTS audio. ● Although you may notice a difference in volume between CDs and DVDs, this is a the result of a difference in disc recording methods. ● Digital output may not be output during Virtual Dolby Digital playback. 	p.35 p.14 p.35

Caution

Static electricity or other external influence may cause malfunctioning of this unit. In this case, unplugging the power cord and then re-plugging it in will usually reset the unit for proper operation. If this does not correct the problem, please consult your the nearest PIONEER service center.

CARE OF DISCS

How to hold discs

When loading or removing discs, try not to touch their playing surfaces.



Cleaning

Fingerprints or other dirt on the disc may affect sound and picture quality.

To clean your discs, use a soft clean cloth to wipe them. If necessary, moisten a soft cloth with diluted neutral detergent to remove heavy dirt or fingerprints.

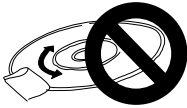

Do not wipe in a circular direction
(Concentric scratches in the disc groove tend to cause noise.)

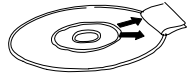

Gently wipe from the inside toward the outer edge.

Discs must not be cleaned with record cleaning sprays, or static prevention sprays, etc. Also do not use volatile liquids such as benzene, or thinner, etc.

NEVER PLAY CRACKED OR WARPED DISCS.

- The disc revolves in the player at high speed when it is played. Never play a cracked, scratched or warped disc. This may damage the player or cause it to malfunction.

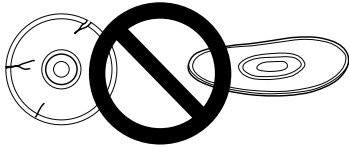

After using discs, store them upright

After playing a disc, always remove it from the player and return it to its jacket. Then store it standing upright away from heat and humidity.

- Store discs carefully. If you store discs at an angle, or stacked on top of each other, discs may become warped even when in their jackets.
- Do not leave discs in locations such as the seat of a car, which may become excessively hot.

CAUTION WHEN USING THE DISC

All rights reserved.

Unauthorized public performance, broadcasting or copying is a violation of applicable laws.

CLEANING CARE

Use a soft, dry cloth for cleaning. For stubborn dirt, soak the cloth in a weak detergent solution; wring well first and wipe. Use a dry cloth to wipe it dry. Do not use any volatile agents such as benzene or paint thinner, as they may damage the surface of the player.

Lens cleaner

The player's pickup lens should not become dirty in normal use, but if for some reason it should malfunction due to soiling, contact your nearest PIONEER authorized service center. Lens cleaners are commercially available, but special care should be exercised in their use since some may cause damage to the lens.

Notes on using the optional optical cable

- Do not route cords around sharp angles. When storing, wind the cords so that they have a diameter of at least 15 cm.
- When connecting, push all the way into the terminal.
- Do not use cords with a length of over 3m.
- If moisture or dust has collected on the plug, wipe it with a soft cloth before connecting.

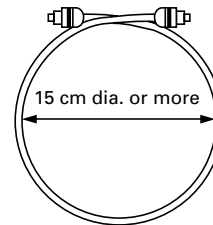

Never use CD's with special shapes.

CD's with special shapes (heart-shaped CDs, octagonal CDs, etc.) cannot be played on this set. Attempting to do so may damage the set. Do not use such CDs.

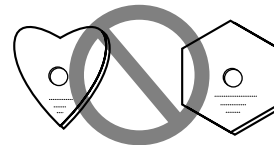

Terms

Dolby Digital (AC-3)*

The maximum 5.1 channels of audio used in the surround system (Surround Digital) for movie theaters is digital data compressed by AC-3.



In order to enjoy Dolby Digital (AC-3) discs, this unit's digital output jack (either coaxial or optical) must be connected to the digital input jack of a Dolby Digital (AC-3) amplifier or processor.

PCM

PCM stands for Pulse Code Modulation and is digital audio. The digital audio of CD or DVD discs is PCM.

DTS

DTS is a surround system different to the Dolby Digital (AC-3) system. In order to enjoy the benefits of DTS discs, the digital output jack (either coaxial or optical) of this player needs to be connected to the DTS input jack of an amplifier or processor.

MPEG

Short for Moving Picture Experts Group. This is an international standard for compression of moving images. On some DVDs digital audio has been compressed and recorded in this format.

Virtual Dolby Surround

Virtual surround sound can be enjoyed with 2 speakers. Select "VDD" or "VDS" in the "Selecting a theater like 3-dimensional sound image (Virtual Dolby Surround)" section on page 38. Virtual Dolby Digital can be enjoyed 3 dimensional sound field processing from the multi channel audio signal takes place. Virtual Dolby Surround can be enjoyed 3 dimensional sound field processing from the 2 channel audio signal takes place.

Title number

Title numbers refer to titles of movies etc. As DVD discs have a large capacity, many movies can be recorded on one disc. For example, when 3 different movies are recorded on a disc, they are divided into TITLE 1, TITLE 2 and TITLE 3. Playback can be operated by selecting the title number.

Legato Link conversion

Although signal frequencies recorded on the discs are limited to no higher than 20KHz, because there are frequency components included in the sound of nature and musical instruments that exceed this, it's not really accurate to say that discs are recorded with the actual original signal wave forms. Legato Link conversion is technology that supposes what the original signal was before it was recorded on the disc in order to realize sound reproduction that is very close to the original sound.

Chapter number

Chapter numbers are the numbers assigned to sections of a title on the disc, similar to chapters in a book. If the disc includes these numbers, you can locate the section you want very quickly using chapter search and other functions.

Time number

The time number is the playback lapse time of a title in the disc from its beginning. The scene you want to locate can be searched for with the time number using the time number function etc..

TOC

TOC (Table Of Contents) information is data other than audio signal data, recorded at the beginning of a disc. As the name implies, it's like the list of contents in a book, with information such as the number of songs and playback time.

Playback Control (PBC)

This refers to signals recorded on a Video CD (Version 2.0) enabling playback control.

You can use menus recorded on discs with PBC for easy, interactive search for desired scenes, and playback.

You can also enjoy viewing high-resolution/standard resolution still images.

Multi-angle

When you watch regular TV programs you are watching the image filmed through the TV camera. Because of this the picture is displayed on your TV from the view point of the TV camera's position. In a TV studio the image is filmed by many cameras at the same time, and one of those images is selected by the program director and transmitted to your TV. If all the filmed images were transmitted to your TV you would be able to select the camera image you want. Some DVD discs are recorded with the angles of all camera's used for filming and these can be selected using this player. These types of discs are called multi-angle discs.

Aspect

Aspect ratio refers to the length to height ratio of TV screens. The ratio of a normal TV is 4:3, while the ratio of a Hi-vision TV or wide TV is 16:9. This allows you to enjoy a picture with a wider perspective.

Parental level

This function was suggested by parents. Parental level restrictions are restrictions incorporated into titles which include scenes that parents do not wish their children to view.

Condition memory

"Condition" refers to the various mode settings etc. On this player, various conditions, such as those set during playback etc. can be memorized. This function allows you to play back the same disc at any time without having to reset the condition settings.

Subtitle

Subtitles are language titles superimposed on movies etc. Up to 32 different subtitle languages can be recorded on a DVD disc. The subtitle function can be used to select the language of your choice.

Regional restriction codes (region number)

Regional restriction codes are built-in to DVD players and DVD discs for each sales region. If the regional code of the DVD player does not match one of the regional codes of the DVD disc, playback will not be possible.

The region number is described on the rear panel.

Optical digital output

Normally, audio is converted to an electric signal and transmitted through an electric wire from the player to the amplifier etc.. Changing this signal to a digital signal and transmitting it through an optical fibre cable is called optical digital output. (Optical digital input is the side receiving the signal from external units such as the amplifier etc.)

Dynamic range

Dynamic range refers to the difference between the maximum conversion level for transmission/conversion of distortion free signals and noise and/or the minimum level limited by the equipment's characteristics. Decibel units (dB) are used.

Component (color difference) video output

The NTSC color signal is divided into the luminance (Y) signal and the color (C_B and C_R) signals and then output. In this way mutual interference of each signal is avoided. On a TV with component input jacks, these signals are synthesized to produce the picture.

Language Code List

● See page 33.

Language	Language-code	Input-code (high-order)	Input-code (low-order)
Japanese	ja	10	01
English	en	05	14
French	fr	06	18
German	de	04	05
Italian	it	09	20
Spanish	es	05	19
Dutch	nl	14	12
Russian	ru	18	21
Chinese	zh	26	08
Korean	ko	11	15
Greek	el	05	12
Afar	aa	01	01
Abkhazian	ab	01	02
Afrikaans	af	01	06
Amharic	am	01	13
Arabic	ar	01	18
Assamese	as	01	19
Aymara	ay	01	25
Azerbaijani	az	01	26
Bashkir	ba	02	01
Belorussian	be	02	05
Bulgarian	bg	02	07
Bihari	bh	02	08
Bislama	bi	02	09
Bengali, Bangla	bn	02	14
Tibetan	bo	02	15
Breton	br	02	18
Catalan	ca	03	01
Corsican	co	03	15
Czech	cs	03	19
Welsh	cy	03	25
Danish	da	04	01
Bhutani	dz	04	26
Esperanto	eo	05	15
Estonian	et	05	20
Basque	eu	05	21
Persian	fa	06	01
Finnish	fi	06	09
Fiji	fj	06	10
Faroese	fo	06	15
Frisian	fy	06	25
Irish	ga	07	01
Scottish Gaelic	gd	07	04
Galician	gl	07	12
Guarani	gn	07	14
Gujarati	gu	07	21
Hausa	ha	08	01

Language	Language-code	Input-code (high-order)	Input-code (low-order)
Hindi	hi	08	09
Croatian	hr	08	18
Hungarian	hu	08	21
Armenian	hy	08	25
Interlingua	ia	09	01
Intperlingue	ie	09	05
Inupiak	ik	09	11
Indonesian	in	09	14
Icelandic	is	09	19
Hebrew	iw	09	23
Yiddish	ji	10	09
Javanese	jw	10	23
Georgian	ka	11	01
Kazakh	kk	11	11
Greenlandic	kl	11	12
Cambodian	km	11	13
Kannada	kn	11	14
Kashmiri	ks	11	19
Kurdish	ku	11	21
Kirghiz	ky	11	25
Latin	la	12	01
Lingala	ln	12	14
Laothian	lo	12	05
Lithuanian	lt	12	20
Latvian, Lettish	lv	12	22
Malagasy	mg	13	07
Maori	mi	13	09
Macedonian	mk	13	11
Malayalam	ml	13	12
Mongolian	mn	13	14
Moldavian	mo	13	15
Marathi	mr	13	18
Malay	ms	13	19
Maltese	mt	13	20
Burmese	my	13	25
Nauru	na	14	01
Nepali	ne	14	05
Norwegian	no	14	15
Occitan	oc	15	03
(Afan) Oromo	om	15	13
Oriya	or	15	18
Panjabi	pa	16	01
Polish	pl	16	12
Pashto, Pushto	ps	16	19
Portuguese	pt	16	20
Quechua	qu	17	21
Rhaeto-Romance	rm	18	13

Language	Language-code	Input-code (high-order)	Input-code (low-order)
Kirundi	rn	18	14
Romanian	ro	18	15
Kinyarwanda	rw	18	23
Sanskrit	sa	19	01
Sindhi	sd	19	04
Sangho	sg	19	07
Serbo-Croatian	sh	19	08
Singhalese	si	19	09
Slovak	sk	19	11
Slovenian	sl	19	12
Samoan	sm	19	13
Shona	sn	19	14
Somali	so	19	15
Albanian	sq	19	17
Serbian	sr	19	18
Siswati	ss	19	19
Sesotho	st	19	20
Sundanese	su	19	21
Swedish	sv	19	22
Swahili	sw	19	23
Tamil	ta	20	01
Telugu	te	20	05
Tajik	tg	20	07
Thai	th	20	08
Tigrinya	ti	20	09
Turkmen	tk	20	11
Tagalog	tl	20	12
Setswana	tn	20	14
Tonga	to	20	15
Turkish	tr	20	18
Tsonga	ts	20	19
Tatar	tt	20	20
Twi	tw	20	23
Ukrainian	uk	21	11
Urdu	ur	21	18
Uzbek	uz	21	26
Vietnamese	vi	22	09
Volapük	vo	22	15
Wolof	wo	23	15
Xhosa	xh	24	08
Yoruba	yo	25	15
Zulu	zu	26	21

Specifications

General

System	DVD system and Compact Disc digital audio system
Power requirements	AC 120 V, 60 Hz
Power consumption	20 W
Power consumption in standby mode	1.5 W
Weight	3.0 kg (6 lb $\frac{5}{8}$ oz)
Dimensions	420 (W) x 283 (D) x 104 (H) mm (16 $\frac{9}{16}$ x 11 $\frac{5}{16}$ x 4 in.) (Not including protruding cables, etc.)
Operating temperature	+5°C to +35°C (+36°F to +96°F)
Operating humidity	5% to 85% (no condensation)

S-Video Output <2 system>

Y (luminance) - Output level	1 Vp-p (75 Ω)
C (color) - Output level	286 mVp-p (75 Ω)
Jacks	S-VIDEO jack

Video Output <2 system>

Output level	1 Vp-p (75 Ω)
Jacks	RCA

Component video output <1 system>

(Y, C _B , C _R)	
Output level	Y: 1.0 Vp-p (75 Ω) C _B , C _R : 0.7 Vp-p (75 Ω)
Output jacks	Pin Jacks

Audio Output <2 system>

Output level	
During audio output	200 mVrms (1 kHz, -20 dB)
Number of channels	2
Jacks	RCA

Digital audio characteristics

Frequency response	4 Hz to 44 kHz (DVD fs: 96 kHz)
S/N ratio	115 dB
Dynamic range	103 dB
Total harmonic distortion	0.002 %
Wow and flutter	Limit of measurement ($\pm 0.001\%$ W. PEAK) or lower

Other Terminals

Optical digital output	Optical digital jack
Coaxial digital output	RCA jack
CONTROL IN/OUT	Minijack (3.5 \emptyset)

Accessories

Remote control unit	1
AA (R6P) dry cell batteries	2
Audio cord	1
Video cord	1
Power cord	1
Operating Instructions	1
Warranty card (Region number ① models only.)	1

NOTE:

The specifications and design of this product are subject to change without notice, due to improvement.



Dear Customer:

Selecting fine audio equipment such as the unit you've just purchased is only the start of your musical enjoyment. Now it's time to consider how you can maximize the fun and excitement your equipment offers. This manufacturer and the Electronic Industries Association's Consumer Electronics Group want you to get the most out of your equipment by playing it at a safe level. One that lets the sound come through loud and clear without annoying blaring or distortion-and, most importantly, without affecting your sensitive hearing.

Sound can be deceiving. Over time your hearing "comfort level" adapts to higher volumes of sound. So what sounds "normal" can actually be loud and harmful to your hearing. Guard against this by setting your equipment at a safe level BEFORE your hearing adapts.

To establish a safe level:

- Start your volume control at a low setting.
- Slowly increase the sound until you can hear it comfortably and clearly, and without distortion.

Once you have established a comfortable sound level:

- Set the dial and leave it there.

Taking a minute to do this now will help to prevent hearing damage or loss in the future. After all, we want you listening for a lifetime.

We Want You Listening For A Lifetime

Used wisely, your new sound equipment will provide a lifetime of fun and enjoyment. Since hearing damage from loud noise is often undetectable until it is too late, this manufacturer and the Electronic Industries Association's Consumer Electronics Group recommend you avoid prolonged exposure to excessive noise. This list of sound levels is included for your protection.

Decibel

Level	Example
30	Quiet library, soft whispers
40	Living room, refrigerator, bedroom away from traffic
50	Light traffic, normal conversation, quiet office
60	Air conditioner at 20 feet, sewing machine
70	Vacuum cleaner, hair dryer, noisy restaurant
80	Average city traffic, garbage disposals, alarm clock at two feet.

THE FOLLOWING NOISES CAN BE DANGEROUS UNDER CONSTANT EXPOSURE

90	Subway, motorcycle, truck traffic, lawn mower
100	Garbage truck, chain saw, pneumatic drill
120	Rock band concert in front of speakers, thunderclap
140	Gunshot blast, jet plane
180	Rocket launching pad

Information courtesy of the Deafness Research Foundation.



Preparation

Basic Operation

Setup

Detailed Operation

Other Information

Should this product require service in the U.S.A. and you wish to locate the nearest Pioneer Authorized Independent Service Company, or if you wish to purchase replacement parts, operating instructions, service manuals, or accessories, please call the number shown below.

8 0 0 – 4 2 1 – 1 4 0 4

Please do not ship your product to Pioneer without first calling the Customer Service Department at the above listed number for assistance.

PIONEER ELECTRONICS SERVICE, INC.
CUSTOMER SERVICE DEPARTMENT
P.O. BOX 1760, LONG BEACH,
CA 90801-1760, U.S.A.

For warranty information please see the Limited Warranty sheet included with your product.

Should this product require service in Canada, please contact a Pioneer Canadian Authorized Dealer to locate the nearest Pioneer Authorized Service Company in Canada. Alternatively, please contact the Customer Service Department at the following address:

Pioneer Electronics of Canada, Inc.
Customer Service Department
300 Allstate Parkway Markham, Ontario
L3R OP2
(905) 479-4411
1-877-283-5901

For warranty information please see the Limited Warranty sheet included with your product.

Si ce produit doit être réparé au Canada, veuillez vous adresser à un distributeur autorisée Pioneer au Canada pour obtenir le nom de la Société de Service Autorisée Pioneer le plus près de chez vous. Ou encore, veuillez vous communiquer avec le Service de Clientèle de Pioneer:

Pioneer électroniques du Canada, Inc.
Département de service au consommateurs
300 Allstate Parkway Markham, Ontario
L3R OP2
(905) 479-4411
1-877-283-5901

Pour obtenir des renseignements sur la garantie, veuillez vous reporter au feuillet sur la Garantie Limitée qui accompagne le produit.

Published by Pioneer Electronic Corporation.
Copyright © 1998 Pioneer Electronic Corporation.
All rights reserved.

PIONEER ELECTRONIC CORPORATION 4-1, Meguro 1-Chome, Meguro-ku, Tokyo 153-8654, Japan

PIONEER ELECTRONICS [USA] INC. P.O. BOX 1540, Long Beach, California 90801-1540

PIONEER ELECTRONICS OF CANADA, INC. 300 Allstate Parkway, Markham, Ontario L3R OP2, Canada

PIONEER ELECTRONIC [EUROPE] N.V. Haven 1087, Keetberglaan 1, 9120 Melsele, Belgium TEL: 03/570.05.11

PIONEER ELECTRONICS AUSTRALIA PTY. LTD. 178-184 Boundary Road, Braeside, Victoria 3195, Australia, TEL: [03] 9586-6300

PIONEER ELECTRONICS DE MEXICO S.A. DE C.V. San Lorenzo Num 1009 3er piso Desp. 302 Col. Del Valle, Mexico D.F. C.P. 03100 TEL: 5-688-52-90